

SpaceMakers

HOME

DAY NIGHT YOUNG

 Zalf

SpaceMakers

design R&S Zalf e Roberto Gobbo

Project concepts _____ P. 02

DAY

Living rooms _____ P. 08

Sideboards _____ P. 34

Tables and Chairs _____ P. 38

NIGHT

Wardrobes / Walk-in closets _____ P. 44

Beds _____ P. 86

Complementary Furniture _____ P. 92

YOUNG

Bedrooms _____ P. 100

Beds _____ P. 128

Desks _____ P. 136

Chairs _____ P. 138

SYSTEMS AND FITTINGS _____ P. 140

TECH _____ P. 166

Sistemi di arredo che diventano strutture architettoniche fruibili in tutte le aree della casa secondo nuovi schemi abitativi - il design che genera spazio. Elementi di contenimento spesso multifunzionali, sempre più dinamici e ridotti, per rispondere alle esigenze dell'abitare contemporaneo. *Decor systems become architectural structures that can be used throughout the house, as new home design dictates - space-generating design. Storage elements are often multi-purpose, ever more dynamic and compact to meet the needs of a contemporary lifestyle.*

SpaceMakers

design R&S Zalf e Roberto Gobbo

Project concepts _____ P. 02

DAY

Compositions _____ P. 08

Sideboards _____ P. 34

Tables and Chairs _____ P. 38

NIGHT

Compositions _____ P. 44

Beds _____ P. 86

Complementary Furniture _____ P. 92

YOUNG

Compositions _____ P. 100

Beds _____ P. 128

Desks _____ P. 136

Chairs _____ P. 138

SYSTEMS AND FITTINGS _____ P. 140

TECH _____ P. 166

Sistemi di arredo che diventano strutture architettoniche fruibili in tutte le aree della casa secondo nuovi schemi abitativi - il design che genera spazio. Elementi di contenimento spesso multifunzionali, sempre più dinamici e ridotti, per rispondere alle esigenze dell'abitare contemporaneo. *Decor systems become architectural structures that can be used throughout the house, as new home design dictates - space-generating design. Storage elements are often multi-purpose, ever more dynamic and compact to meet the needs of a contemporary lifestyle.*

Concetti progettuali *Project concepts*

Alla base di ogni creazione Zalf ci sono tre pilastri progettuali che tracciano il percorso verso un design unico: Trasversalità, Spazialità e Versatilità.

There are three design pillars that trace the path to unique design behind every Zalf creation: Transversal, Spacious, Versatile.

Project concepts

Trasversalità *Transversal*

Sistemi living, armadi e cabine armadio, combinabili e compatibili per finiture e dimensionamento, in profondità ed in altezza.
Living room systems as well as walk-in closets and wardrobes, all of which can be combined and are compatible in terms of finishes and sizes, both in depth and height.

Risolvere esigenze diversificate legate alle caratteristiche fisiche dello spazio abitativo attraverso la trasversalità dei sistemi.
Satisfying various requirements linked to the physical characteristics of the spaces available in a home, thanks to the cross-functionality of systems.



Project concepts

Spazialità *Spacious*

Articolare lo spazio generando soluzioni che contengono le funzioni abitative, in modo flessibile e senza la necessità di partiture verticali, con sistemi retrofiniti, accostabili schiena con schiena per tutti i moduli e funzioni, su misura nelle tre dimensioni.

Organising spaces by flexibly generating solutions that contain the functions typical of a home, with no need for vertical partitions, using systems that are finished on the rear or can be fitted back-to-back for all modules and functions and that are available made-to-measure in all three dimensions.

Nello stesso open space, dalle dimensioni contenute di 70 mq, e nella stessa unità residenziale, dalle dimensioni importanti, quattro progetti d'arredo che articolano lo spazio secondo le proprie esigenze ed il proprio gusto. *Four furnishing projects organise spaces to suit the requirements and tastes of users. They are located in the same large residential unit and in the same 70 square metre space.*

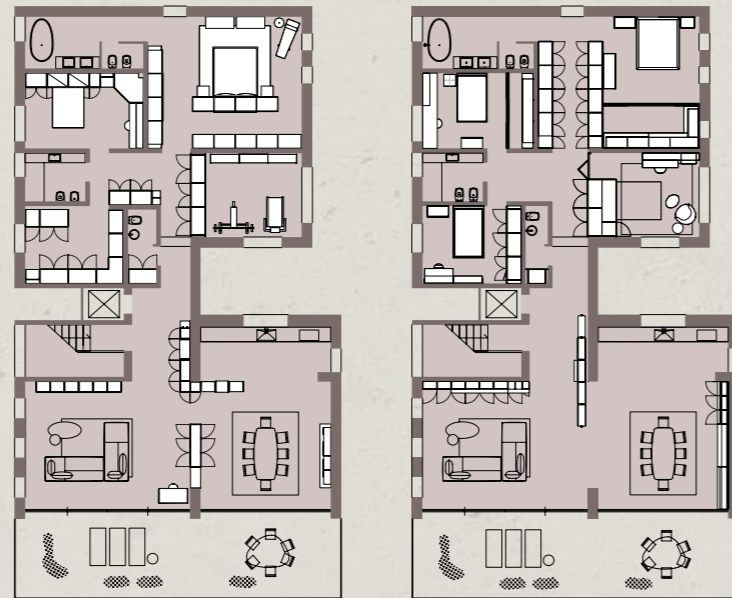
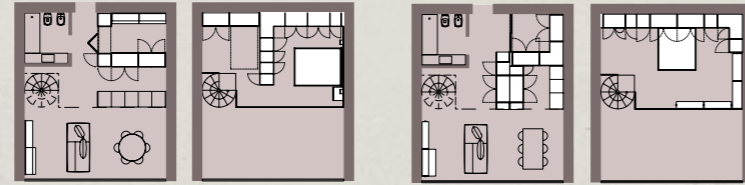

Project concepts

Versatilità *Versatile*

Dare risposte abitative alle famiglie tradizionali, allargate, multigenerazionali alle persone singole e ad altre forme di convivenza. *Offering solutions for the home to traditional, extended and multi-generational families, single people and other types of cohabitation.*

Rispondere a più tipologie abitative prestabilite o trasformative, in quest'ultimo caso consentendo di progettare diverse modalità di utilizzo degli spazi. Dal living allo studio, dalla camera principale alla cabina guardaroba, dagli spazi di connessione ai locali di servizio, differenziando la qualità estetica delle soluzioni progettuali e compiendo sempre scelte giuste, anche nel prezzo. *Meeting the requirements of various types of fixed or transformative homes, in the latter case offering the possibility of planning different ways of using spaces. From the living room to the study, from the master bedroom to the walk-in closet, from corridors to utility rooms, this system lets you differentiate the aesthetic quality of projects so that the right choice can be made at all times.*



DAY

SM2514



Modular pannelli opus cemento e noce, mensole in metallo brunito, scrittoio noce. Pensili anta City Glass vetro trasparente fumé e telaio brunito, struttura noce, ripiani interni in vetro. Basi contenitori a terra piano top e copri fianchi sp.1,2 cm noce. Freespace moduli a terra anta Gola opus cemento con nicchia noce e ripiani in vetro. Poltrona Eben e tavolino Dorvan by Desiree. Opus concrete and walnut Modular panels, burnished metal shelves, walnut desk. Wall units with City Glass fumé transparent glass doors with a burnished frame, walnut structure, internal glass shelves. Walnut floor-level base storage units and 1.2 cm thick finishing side panels. Freespace floor-level modules with opus concrete Gola doors, a walnut niche, glass shelves. Eben armchair, Dorvan side table by Desiree.

SM2521



Modulor pannelli rovere natural, Unoedue pensili a giorno opus calce, pensile ante City Glass opus calce, vetro trasparente cannettato e telaio brunito; Unoedue base a giorno in appoggio rovere natural, basi sospese opus calce. Divano Lovely Day by Desiree. *Natural oak Modulor panels, opus lime Unoedue open wall units, wall unit with opus lime City Glass doors in transparent fluted glass with a burnished frame; natural oak Unoedue elevated open base unit, opus lime wall-hung base unit. Lovely Day sofa by Desiree.*

SM2225



Modular pannelli carbone, pensili pomice ante City Glass vetro trasparente e telaio brunito, pensili ante ribalta Plana push&pull noce; basi sospese cassettoni ante ribalta Plana push&pull noce, Unoedue basi sospese a giorno noce, mensole in metallo brunito.
Coal Modular panels, pumice wall units with City Glass doors, transparent glass and burnished frames; walnut wall units with Plana push&pull drop-down doors; walnut wall-hung base units with Plana push&pull deep drawer fronts, walnut Unoedue open wall-hung base units, burnished metal shelves.

SM2203



Modulor pannelli carbone, pensili ante Plana push&pull carbone, pensili e base sospesa Unoedue a giorno noce, basi sospese ante ribalta Plana push&pull carbone. Divano Ludwig by Desiree.
Coal Modulor panel; wall units with coal Plana push&pull doors; walnut Unoedue wall units and open wall-hung base units; wall-hung base units with coal, Plana push&pull drop-down doors. Ludwig sofa by Desiree.



SM2502

Modulor pannelli e Unoedue pensili a giorno carbone, pensile opus cemento anta City Glass brunito e vetro trasparente cannettato; basi sospese ante ribalta Plana push&pull opus cemento, base sospesa a giorno Unoedue carbone. Divano Boog by Desiree. *Coal Modulor panels and Unoedue open wall unit, opus concrete wall unit with City Glass doors in transparent fluted glass and burnished frame; suspended base units with opus concrete Plana push&pull flap doors, coal Unoedue open suspended base unit. Boog sofa by Desiree.*



SM2520

Freespace moduli sospesi struttura noce e schiene opus cemento, anta Plana push&pull opus cemento, anta City Glass vetro trasparente cannettato e telaio brunito, modulo sospeso porta TV opus cemento, basi a terra cassettone e ribalta Plana push&pull top e copri fianchi sp.1,2 cm opus cemento, vassoio noce.
Walnut Freespace wall-hung modules with opus concrete back panels, opus concrete Plana push&pull doors, City Glass doors in transparent fluted glass with a burnished frame, opus concrete wall-hung TV module; floor-level base units, deep drawer and Plana push&pull drop-down doors, opus concrete 1.2 cm thick top and finishing side panels, walnut tray.

SM2212

Freespace moduli sospesi ottanio e carbone con ante City Glass vetro trasparente e telaio brunito, scrittoio carbone. Panca Ludwig by Desiree.
Freespace octane and coal wall-hung shelving system with transparent glass City Glass doors and burnished frames. Coal desk. Ludwig bench by Desiree.



SM2503



Freespace moduli a terra opus calce e opus mattone, nicchia con specchio opus mattone, ante Gola opus calce, ante City Glass vetro trasparente cannettato. Modulo a terra angolo aperto con nicchia ad angolo opus mattone, nicchia con seduta opus mattone, cuscino Creta C1F. Modulo terminale opus calce con ante Plana senza maniglia. *Opus lime and opus brick Freespace floor-level modules, opus brick niche with mirror, opus lime Gola doors, City Glass doors in transparent fluted glass. Open-corner floor-level module with opus brick corner niche, niche with opus brick seat. Creta C1F cushion. Opus lime end module with Plana door without a handle.*



SM2522



Freespace moduli a terra monofacciali anta City Glass vetro trasparente cannettato e telaio brunito, moduli a terra monofacciali con ripiani discontinui bianco talco. Tavolo e sedia Ciàcola by Desiree.
Freespace single-sided floor-level modules, City Glass doors in transparent fluted glass with a burnished frame, single-sided floor-level modules with talc white discontinuous shelves. Ciàcola table and chair by Desiree

SM2222



Freespace sistema a spalla bifacciale noce con ante City Glass vetro trasparente fumé e telaio brunito;
Sign scrittoio struttura metallo brunito, piano noce, screen imbottito tessuto Creta C07.
*Freespace double-sided shelving system in walnut with City Glass doors in fumé transparent glass with a
burnished frame; Sign desk with a burnished metal structure, walnut top, upholstered screen in Creta C07 fabric.*

SM2224

Windy sistema con palo a soffitto, mensole carbone, contenitori ante ribalta Plana push&pull noce, contenitori ante vasistas City Glass noce, vetro trasparente fumé e telaio brunito; pannello Siparium tessuto Smack S03 con sacca porta oggetti tessuto Creta C07, scrittoio noce. Windy system with floor-to-ceiling poles, coal shelves, walnut units with Plana push&pull drop-down doors, walnut wall units with City Glass lift-up doors in fumé transparent glass with a burnished frame; Siparium upholstered panel in Smack S03 fabric, with Creta C07 fabric hanging organisers; walnut desk.



SM2003



Windy sistema con palo a parete, pali e reggimensole brunito, ripiani Trai 45 con telaio in alluminio brunito e vetro trasparente, piano scrittoio sp.5 cm arena.
Windy system with burnished floor-to-wall poles and shelf brackets, Trai 45 shelves with burnished aluminium frames and transparent glass; 5 cm thick arena desk.



SM2205



Flexy Easy sistema a cremagliera brunito con mensole cashmere, contenitori ante vasistas Plana push&pull cashmere, Sign scrittoio struttura in metallo brunito, piano in vetro brunito opaco.
Flexy Easy burnished rack system with cashmere shelves; cashmere storage units with Plana push&pull lift-up doors; Sign desk with a burnished metal structure and a matt burnished glass top.

Madie Sideboards



Madia L.240 H.59,3 cm con basamento brunito, top e piano sopra basamento opus calce.
 Contenitori anta Plana push&pull opus mattone e opus calce, elementi a giorno ottanio e opus mattone.
*Sideboard measuring W.240 H.59.3 cm with a burnished base, opus lime top and base top panel.
 Opus brick and opus lime units with Plana push&pull doors, ottanio and opus brick open units.*



Madia L.240 H.77,7 cm con basamento brunito, top e piano sopra basamento lignum dark.
 Contenitori anta Plana opus cemento e pomice maniglia Roll brunito, elemento a giorno lignum dark.
*Sideboard measuring W.240 H.77.7 cm with a burnished base, lignum dark top and base top panel.
 Units with opus concrete and pumice Plana doors and burnished Roll handles. Lignum dark open unit.*

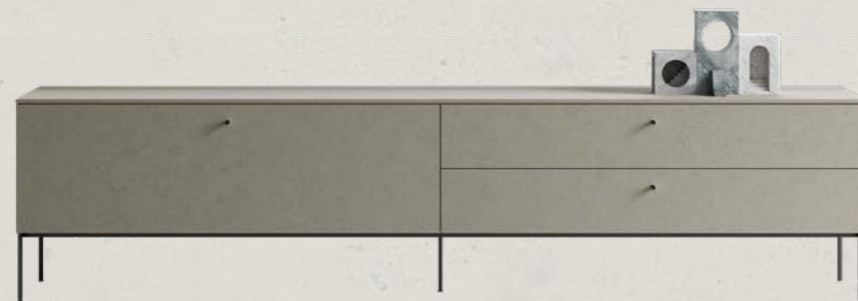

Madia L.240 H.58,1 cm con basamento brunito, top opus cemento.
 Contenitori anta Plana opus cemento maniglia Roll brunito.
*Sideboard measuring W.240 H.58.1 cm with a burnished base and a opus
 concrete top. Units with opus concrete Plana doors and burnished Roll handles.*



Madia L.270 H.59,3 cm con basamento componibile brunito, top e piano sopra basamento rovere natural.
 Contenitori ante Plana rovere natural, ottanio, bianco talco con maniglia Roll brunito, elemento a giorno ottanio.
*Sideboard measuring W.270 H.59.3 cm with a burnished modular base, natural oak top and base top panel.
 Natural oak, octane and talc white units with Plana doors and burnished Roll handles. Octane open unit.*

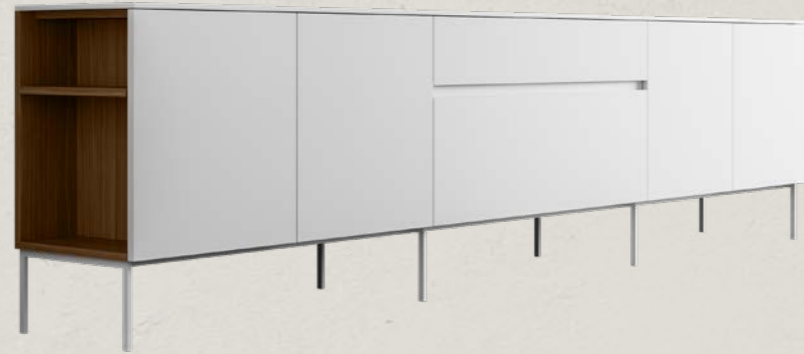

Madia L.270 H.76,5 cm con basamento componibile bianco, top bianco talco. Contenitori anta Plana push&pull e anta Grip bianco talco; terminali interno noce anta battente bianco talco.
Sideboard measuring W.270 H.76.5 cm with a white modular base. Talc white top. Units with Plana push&pull doors and talc white Grip fronts; end units with walnut interiors and talc white hinged doors.



Madia L.122,4 H.131,7 cm con basamento brunito, top e coprifianchi noce. Contenitori anta Plana noce maniglia Roll brunito.
Sideboard measuring W.122.4 H.131.7 cm with a burnished base, walnut top and finishing side panels. Units with walnut Plana doors and burnished Roll handles.



Madia L.270 H.77,7 cm con basamento componibile brunito, top e piano sopra basamento lignum dark. Contenitori anta Plana push&pull bianco talco e anta Plana carbone maniglia Roll brunito, elemento a giorno lignum dark.
Sideboard measuring W.270 H.77.7 cm with a burnished modular base, lignum dark top and base top panel. Units with talc white push&pull doors and coal Plana fronts with burnished Roll handles. Lignum dark open unit.

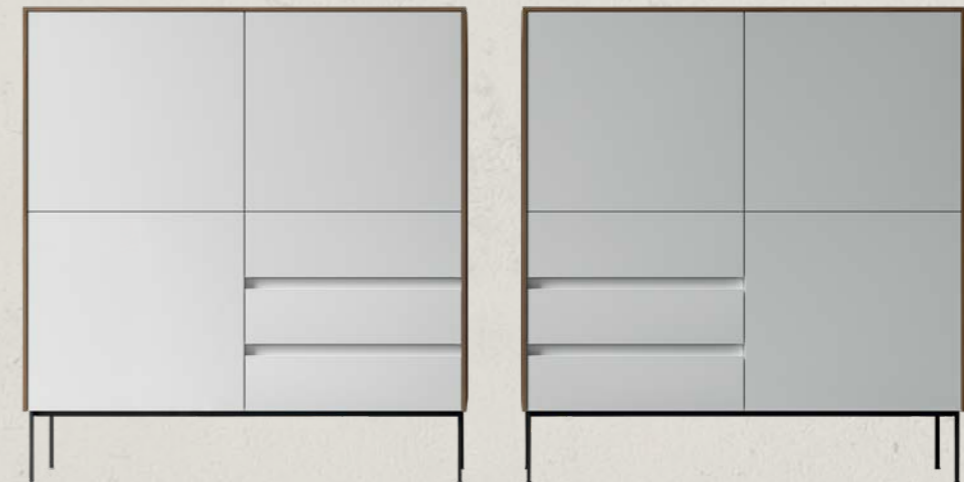

Madia L.122,4 H.131,7 cm con basamento brunito, top e coprifianchi noce. Contenitori anta Plana push&pull e anta Grip bianco talco.
Sideboard measuring W.122.4 H.131.7 cm with a burnished base, walnut top and finishing side panel. Units with Plana push&pull doors and talc white Grip fronts.

Tavoli e Sedie Tables and Chairs



Thin | Kanvas

Tavolo Thin rettangolare in metallo verniciato nero. Sedia Kanvas struttura a traliccio in filo verniciata nero, scocca in tecnopolimero nero.
Thin rectangular table in black painted metal. Kanvas chair with a black-painted, lattice wire structure and a body in black technopolymer.



Thin | Isidora

Tavolo Thin rettangolare in metallo verniciato bianco. Sedia Isidora in tecnopolimero bianco, perla, pistacchio, sabbia.
Rectangular Thin table in white-painted metal. Isidora chair in white, pearl grey, pistachio green and sand technopolymer.



Thin | Main

Tavolo Thin rettangolare in metallo verniciato nero. Sedia Main rivestita in ecopelle ignifuga avorio.
Rectangular Thin table in black-painted metal. Main upholstered chair in ivory fireproof eco-leather.



Star | Shell

Tavolo Star struttura e gambe in metallo brunito, piano in opus mattone. Sedia Shell con struttura in metallo brunito, scocca in pelle testa di moro.
Star table with burnished metal structure and legs, opus brick top. Shell chair with burnished metal structure, dark brown leather body.



Angolo | Fuller

Tavolo Angolo struttura e gambe in metallo 10x2 cm brunito, piano in vetro lucido brunito. Sedia con braccioli Fuller, struttura a traliccio in filo verniciata in metallo con braccioli, scocca in tecnopolimero nero.
Angolo table with a 10x2 cm burnished metal structure and legs. Glossy burnished glass top. Fuller chair with armrests, a painted metal lattice wire structure with armrests and a black technopolymer body.



Angolo All | Kanvas

Tavolo Angolo All struttura allungabile e gambe in metallo 10x2 cm bianco, piano in melaminico sp.1,8 cm rovere natural. Sedia Kanvas con struttura a traliccio in filo verniciata bianco, scocca in tecnopolimero bianco.
Angolo extending table with a white, 10x2 cm metal structure and legs. 1.8 cm thick, natural oak melamine top. Kanvas chair with a white-painted, lattice wire structure, white technopolymer body.



Angolo | Bakhita

Tavolo Angolo struttura e gambe in metallo 10x2 cm bianco, piano in melaminico sp.1,8 cm bianco talco. Sedia Bakhita in tecnopolimero sabbia.
Angolo table with a white, 10x2 cm metal structure and legs. 1.8 cm thick, talc white melamine top. Sand technopolymer Bakhita chair.



Minimus | Compass

Tavolo Minimus struttura gambe in metallo 5x5 cm brunito, piano in melaminico sp.1,8 cm carbone. Sedia Compass, struttura in metallo brunito, seduta imbottita rivestita in ecopelle testa di moro.
Minimus table burnished, 5x5 cm metal legs and structure and a 1.8 cm thick coal melamine top. Compass chair with a burnished metal structure and a padded seat upholstered in dark brown eco-leather.

NIGHT

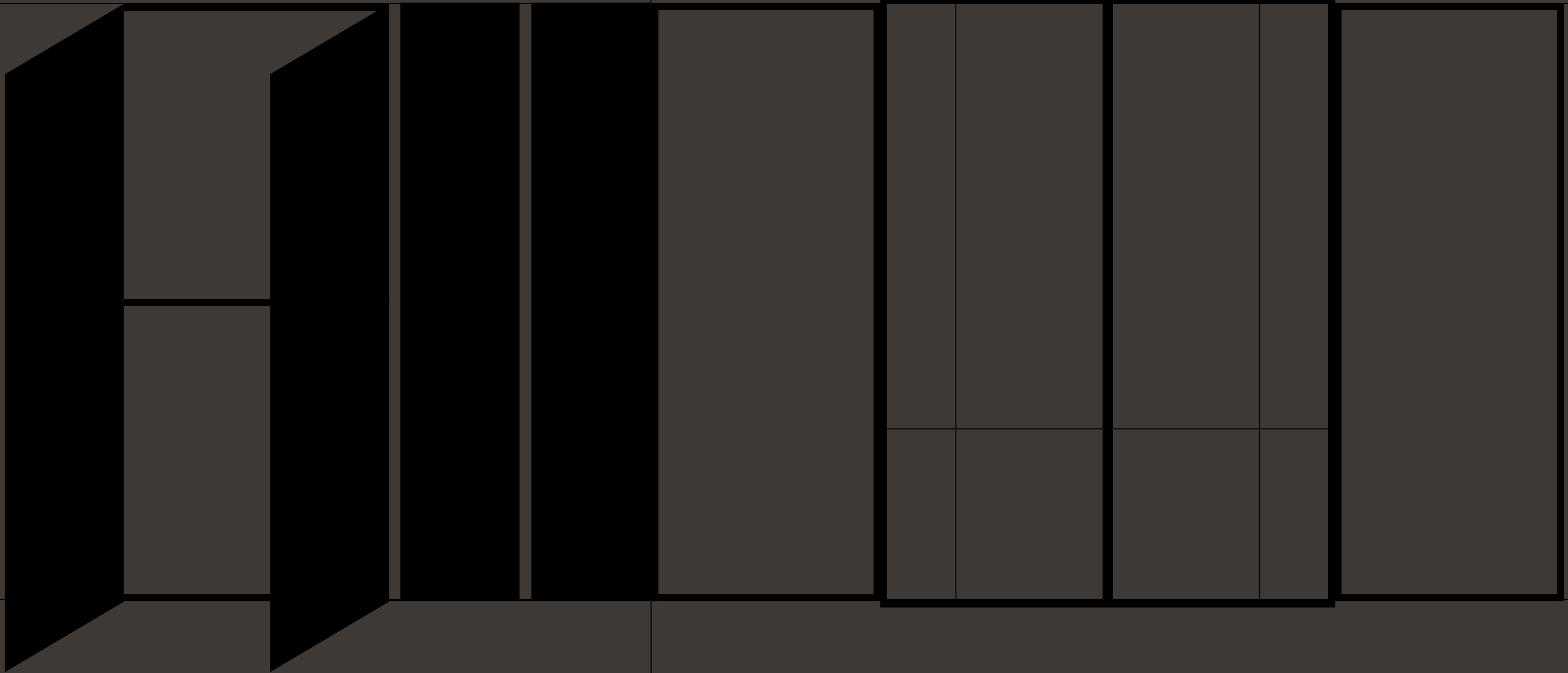

SM2527



Alternata armadio battente anta City pomice e telaio pomice, anta a libro City Glass vetro riflettente chiaro e telaio brunito. Interno e accessori in noce, illuminazione ad incasso sui fianchi, fianco esterno pomice. Poltrona Kara by Desiree.
Alternata hinged door wardrobe with pumice City doors and pumice frame, City Glass folding doors in clear reflective glass and a burnished frame. Walnut interior and accessories, recessed lighting on the side panels, pumice end side. Kara armchair by Desiree.

SM2504

Alternativa armadio battente con anta a libro City Glass vetro trasparente fumé. Interno e accessori in noce, illuminazione ad incasso sui fianchi.
Alternativa hinged door wardrobe with City Glass folding doors in fumé transparent glass. Walnut interior and accessories, recessed lighting on the end sides.





SM2523



Alterna armadio battente anta Plana ardesia, maniglia Cilindro brunito e moduli sovrapponibili anta Plana push&pull noce. Interni noce. Divano Ludwig by Desiree.
Alterna hinged door wardrobe with slate Plana doors, burnished Cilindro handle and overhead modules, walnut Plana push&pull doors. Walnut interiors. Ludwig sofa by Desiree.

SM2524



Alternata armadio battente anta Mixer opus mattone, profilo brunito, interni sesamo, fianco esterno opus mattone. Flexy pannello e accessori lignum dark. Float letto lignum dark. Poltrona Le Midi by Desiree.
Alternata hinged door wardrobe with opus brick Mixer doors, burnished profile, sesame interiors, opus brick end side. Lignum dark Flexy panel and accessories. Lignum dark Float bed. Le Midi armchair by Desiree.

SM2525



Alternativa armadio battente anta Plana opus calce maniglia Virgola cashmere, basi armadio cassettoni opus calce, maniglia Grip cashmere. Pannelli testata opus calce e testata imbottita tessuto Funny S54, comodino Simply noce, giroletto contenitore con unione a 45° opus calce. Alternativa hinged door wardrobe with opus lime Plana doors and cashmere Virgola handle, opus lime deep-drawer wardrobe base unit, cashmere Grip handle. Opus lime headboard panels and upholstered headboard in Funny S54 fabric, walnut Simply bedside table, opus lime storage bed frame joined at 45°.

SM2072



Alternata armadio battente ante City noce e City Glass vetro trasparente fumé, telaio brunito; struttura finitura esterna e interna noce.
Alternata hinged door wardrobe with walnut City doors and fumé transparent glass City Glass doors with burnished frames. Internal and external finish in walnut.





SM2005



Alternata armadio battente con modulo angolare, modulo con cassettoni ante Plana ottanio maniglia Bench lignum dark e Grip ottanio. Pannelli testata lignum dark con led, testata imbottita trapuntata Mirò e Giroletto imbottito H.32 cm tessuto Funny S52, comodino Gap lignum dark.
Alternata hinged door wardrobe with a corner module, a module with deep drawers and octane Plana fronts, lignum dark Bench handle and octane Grip profile. Lignum dark headboard panels with led lights, Mirò quilted headboard and 32 cm high bed frame upholstered in Funny S52 fabric, lignum dark Gap bedside tables.

SM2011

Alternativa armadio battente e modulo letto a ribalta bianco talco, apertura push&pull. Scrittoio sospeso e mensole rovere natural. Set settimanale rovere natural. Alternativa hinged door wardrobe and folding bed module in talc white, push&pull fronts. Natural oak floating desk and shelves. Natural oak Set chest of drawers.





SM2001



Alterna armadio battente con modulo angolare ante Gola pomice. Moduli ponte ante Plana, pannelli sottoponte e mensola pomice, scrittoio sp.5 cm arena. Windy sistema con palo a soffitto a misura mansardato, pali e reggimensole brunito, mensole arena. Luk Big letto imbottito con giroletto H.19 cm tessuto Funny S59, gambe Topper brunito. Alterna hinged door wardrobe with corner module and pumice Gola doors. Overhead modules with Plana doors, pumice panels and shelf under the modules; 5 cm thick arena desk. Windy system with burnished, floor-to-ceiling poles, made-to-measure for sloping ceilings, burnished poles and shelf brackets, arena shelves. Luk Big padded bed with a 19 cm high bed frame upholstered in Funny S59 fabric; burnished Topper legs.

SM2531

Alternata armadio scorrevole ante Gola profili e pannelli opus calce, interni sesamo, fianco esterno opus calce. Poltrona Rito, pouf Rollking e tavolino Yori by Desiree.
Alternata sliding door wardrobe with Gola doors, opus lime profiles and panels, sesame interiors, opus lime end side. Rito armchair, Rollking pouf and Yori side table by Desiree.



SM2014B



Alterna armadio scorrevole ante centrali Double Glass profili brunito pannelli cretto cashmere e vetro cashmere opaco; ante esterne Mixer profili brunito pannelli cretto cashmere; ante di finitura posteriori cretto cashmere.
Alterna sliding door wardrobe with Double Glass central doors, burnished edges, cretto cashmere and matt cashmere glass panels. Mixer side doors with burnished edges and cretto cashmere panels; cretto cashmere rear finishing panels.



SM2014C

Alterna armadio scorrevole ante centrali Mondrian
profili brunito, pannelli cashmere; ante esterne
Compass profili brunito, pannelli cashmere.
*Alterna sliding door wardrobe featuring Mondrian central
doors with burnished trims and cashmere panels; Compass
side doors with burnished trims and cashmere panels.*



SM2532

Flexy cabina armadio pannelli opus mattone e accessori noce. Alternata armadio battente ante City Glass vetro cannettato, profilo brunito, finitura esterna ed interna noce. Trend isola comò noce. Porte di chiusura scorrevoli in vetro trasparente fumé, telaio titanio spazzolato. Letto Shellon by Desiree. Comodini Grip noce, profili brunito.
Flexy walk-in closet, opus brick panels and walnut accessories. Alternata hinged door wardrobe with City Glass doors in transparent fluted glass, burnished profile, walnut interior and exterior finish. Walnut, double-sided Trend chest of drawers. Sliding door closing system in fumé transparent glass, brushed titanium frame. Shellon bed by Desiree. Walnut Grip bedside tables, burnished profiles.



SM2526

Flexy cabina armadio con pannelli e accessori rovere natural, reggimensole e appendiabiti brunito. Alterna armadio battente anta Gola opus cemento e profilo brunito, finitura interna sesamo. Pouf Melvil by Desiree.
Flexy walk-in closet with natural oak panels and accessories, burnished shelf brackets and hanging rails. Alterna hinged door wardrobe with opus concrete Gola doors and burnished profile, sesame interior finish. Pouf Melvil by Desiree.



Flexy cabina armadio pannelli cretto cashmere, reggimensole e appendiabiti brunito, accessori arena. Porte di chiusura scorrevoli in vetro trasparente bronzato e telaio nero spazzolato.
Flexy walk-in closet with cretto cashmere panels, burnished shelf brackets and hanging rails, arena accessories. Sliding door closing system in bronze transparent glass with brushed black frames.

SM2004



Alternata armadio battente ante Plana push&pull e ante Mixer con modulo angolo esterno e ante di finitura posteriori ottanio. Chiusura a soffietto anta Mixer e profilo ottanio.
Flexy cabina pannelli cocò, reggimensole e appendiabiti brunito, mensole e accessori ottanio.
Alternata hinged door wardrobe with Plana push&pull doors and Mixer doors with an external corner module and octane rear panels. Octane Mixer folding doors and door profile. Flexy walk-in closet with cocò panels, burnished shelf brackets and hanging rails, octane shelves and accessories.



SM2014A

Free cabina armadio fianchi, ripiani e accessori noce, schiene sesamo.
Modulo terminale con appendino brunito, noce.
*Free walk-in closet with walnut sides, shelves and accessories, sesame
back panels. End module with a burnished hanging rail and a walnut base.*

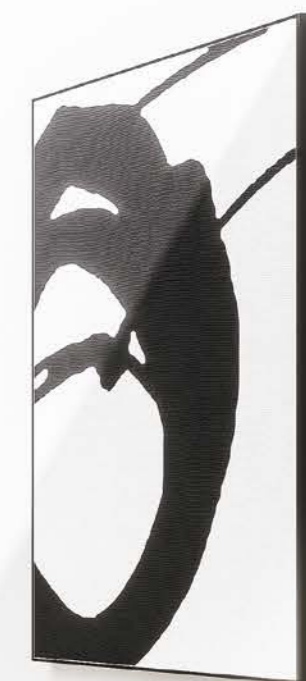

SM010



Windy sistema a palo con pali a soffitto bruniti, mensole pomice e vassoi estraibili Trai 45 con frontalino in vetro.
Windy pole shelving system with burnished floor-to-ceiling poles, pumice shelves and Trai 45 pull-out trays with glass fronts.



SM013



Flexy Easy cabina armadio con montanti e reggimensole brunito, mensole, cassettiere e portacamicia arena.
Flexy Easy walk-in closet with burnished racks and shelf brackets; arena shelves, drawer units and shirt tray.

SM2505

MODULI IN TRE DIFFERENTI PROFONDITÀ MODULES IN 3 DIFFERENT DEPTHS

Alternata armadio battente anta Gola cashmere, nicchia armadio anta Plana cashmere, cassettoni rovere natural profilo Grip cashmere, modulo di servizio e modulo elettrodomestici doppi anta Gola cashmere, Freespace modulo a terra monofacciale rovere natural. Panca Ludwig e tavolino Sabi by Desiree.
Alternata hinged door wardrobe with cashmere Gola doors, wardrobe niche with cashmere Plana door, natural oak deep drawers, cashmere Grip profile, utility module and double household appliance module, cashmere Gola door, natural oak Freespace single-sided floor-level module. Ludwig bench and Sabi side table by Desiree.

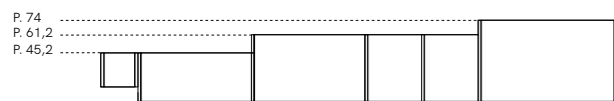



SM007



Alterna armadio battente ante Plana e maniglia Virgola cashmere con modulo di servizio, modulo elettrodomestici, anta ripostiglio e passaggio con chiusura battente.
Alterna hinged door wardrobe with Plana doors and cashmere Virgola handles with a utility module, a household appliance module, a cupboard door and a doorway with a hinged door.

Letti Beds



Blunt | Decor

Letto imbottito Blunt con testata e giroletto H.12 cm con unione a 45°, gambe in metallo Raked, Topper o Ruler. Letto imbottito Decor testata con decoro, giroletto H.12 cm, gambe in metallo Raked, Topper o Ruler. Nell'immagine letto Blunt in tessuto Creta C53, gamba Ruler in metallo brunito.
Blunt padded bed with headboard and bed frame H.12 cm joined at 45°. Raked, Topper or Ruler legs in metal. Decor padded bed with embellished headboard and bed frame H.12 cm. Raked, Topper or Ruler legs in metal. Shown: Blunt bed upholstered in Creta C53 fabric. Ruler legs in burnished metal.



Luk Small | Luk Big

Letto imbottito con testata in due altezze, giroletto H.19 cm e gambe in metallo Topper, Raked o Ruler. Nell'immagine letto Luk Small in tessuto Funny S51, gamba Topper in metallo brunito.
Padded bed with headboard available in two heights, bed frame H.19 cm and Raked, Topper or Ruler legs in metal. Shown: Luk Small bed upholstered in Funny S51 fabric, Topper legs in burnished metal.



Spoon

Letto imbottito con testata dalla forma sinuosa e giroletto H.19 cm, gambe in metallo Topper, Raked o Ruler. Nell'immagine letto Spoon L.120 cm in tessuto Funny S56, gamba Topper in metallo brunito.
Padded bed with a convex-shaped headboard; bed frame H.19 cm. Raked, Topper or Ruler legs in metal. Shown: Spoon bed W.120 cm upholstered in Funny S56 fabric with Topper legs in burnished metal.



Slim

Letto imbottito con testata dalla leggera curvatura e giroletto H.32 cm. Nell'immagine letto imbottito Slim, tessuto Creta C8N, comodini Trend L.77,4 cm rovere natural.
Padded bed with a slightly curved headboard and a bed frame H.32 cm. Shown: padded Slim bed upholstered in Creta C8N fabric. Natural oak Trend bedside tables W.77.4 cm.



Icon Small | Icon Big

Letto imbottito con testata caratterizzata da un particolare disegno, disponibile in due altezze, giroletto H.32 cm. Nell'immagine letto imbottito Icon Small in tessuto Funny S64.
Padded bed featuring an original design, available in two heights; bed frame H.32 cm. Shown: padded Icon Small bed upholstered in Funny S64 fabric.



Float

Giroletto superiore H.9 cm ring 90°, giroletto inferiore H.22 cm con box contenitore, pannello testata sospeso H.71 cm in melaminico. Nell'immagine letto Float noce, comodini sospesi Gap bianco talco.
Upper bed frame H.9 with 90° joints, lower bed frame H.22 cm with storage, wall-hung headboard panel H.71 cm in melamine. Shown: walnut Float bed and wall-hung Gap bedside tables in talc white.



Pannelli testate e giroletto H.39 | Headboard panels and bed frame H.39

Nell'immagine letto con testata imbottita a terra tessuto Creta C8N, 1 pannello centrale L.175 cm con distanziale e 2 pannelli laterali L.60 cm H.111,4 cm lignum dark con illuminazione, giroletto H.29 cm ring 90° ardesia con box contenitore, comodino sospeso Gap L.45 cm lignum dark e tavolino Tac ardesia.
Shown: bed with a padded, floor-level headboard upholstered in Creta C8N fabric; 1 central panel W.175 cm with spacer and 2 side panels W.60 cm H.111.4 cm, all in lignum dark with lighting. Slate bed frame H.29 cm with 90° joints and storage base, lignum dark Gap wall-hung bedside table W.45 cm. Slate Tac side table.



Pannelli testate e giroletto imbottito | Headboard panels and padded bed frame

Giroletto imbottito H.32 cm con box contenitore opzionale. Nell'immagine giroletto imbottito tessuto Creta C41, testata con 1 pannello centrale L.175 cm e 2 pannelli laterali L.60 cm H.111,4 cm ardesia con illuminazione, comodino pensile Frame L.45 cm ardesia.
Padded bed frame H.32 cm with optional storage. Shown: padded bed frame upholstered in Creta C41 fabric, slate headboard panelling with 1 central panel W.175 cm and 2 side panels W.60 cm H.111.4 cm with lighting. Frame wall-hung bedside table W.45 in slate.



Testata Bent e giroletto H.29 | Bent headboard and bed frame H.29

Nell'immagine letto Bent testata ottanio con cuffia Klee tessuto Creta C1F, giroletto H.29 cm ring a 90° con zoccolo ottanio.
Shown: Bent bed with octane headboard and Klee slipcover in Creta C1F fabric. Bed frame H.29 cm with 90° joints and octane plinth.



Testata Soft e giroletto H.9 gambe R30 | Soft headboard and bed frame H.9 and R30 legs

Nell'immagine letto Soft con testata imbottita tessuto Creta C85, giroletto H.9 cm e gambe R30 ardesia.
Shown: Soft bed with padded headboard upholstered in Creta C85 fabric. Slate bed frame H.9 cm and slate R30 legs.



Testata Fold e giroletto H.9 con gambe a 45° | Fold headboard and bed frame H.9 with legs featuring 45° joints

Nell'immagine letto Fold testata arena con cuffia Mirò tessuto Creta C01, giroletto H.9 cm con gambe a 45°.
Shown: arena Fold bed and headboard featuring a Mirò slipcover in Creta C01 fabric, bed frame H.9 cm with legs featuring 45° joints.



Testata Wing e giroletto H.19 gambe Topper | Wing headboard and bed frame H.19 and Topper legs

Nell'immagine letto Wing con testata imbottita tessuto Creta C8N, giroletto H.19 cm ring 45° noce e gambe Topper brunite.
Shown: Wing bed with padded headboard upholstered in Creta C8N fabric, featuring walnut bed frame H.19 with 45° joints and burnished Topper legs.

Complementi Complementary furniture



Speed

Complementi Speed: comodini H.30,5 cm L.45 cm e L.90 cm ottanio, comodino H.48,9 cm L.60 cm noce, comò L.120 cm ardesia, settimanale L.95 cm noce.
Speed complementary furniture: octane bedside tables H.30.5 cm W.45 cm and W.90 cm, walnut bedside tables H.48.9 cm W.60 cm, slate chest of drawers W.120 cm, walnut chest of drawers W.95 cm.



Trend

Complementi Trend: comodino H.47,7 cm L.62,4 cm arena top vetro arena opaco, comodino H.47,7 cm L.77,4 cm pomice top vetro pomice opaco, comò L.122,4 cm arena e pomice top vetro pomice opaco, settimanale L.92,4 cm ottanio top vetro ottanio opaco.
Trend complementary furniture: arena bedside table H.47.7 cm W.62.4 cm with a matt arena glass top, pumice bedside table H.47.7 cm W.77.4 cm with matt pumice glass top, arena and pumice chest of drawers W.122.4 cm with matt pumice glass top, octane chest of drawers W.92.4 cm with matt octane glass top.



Lucky

Complementi Lucky: comodino H.38,5 cm L.90 cm ardesia gambe brunito, comodino H.47,7 cm L.60 cm bianco talco gambe bianche, comò L.150 cm olmo ash gambe bianche, settimanali L.45 cm opus cemento gambe brunito.
Lucky complementary furniture: slate bedside table H.38.5 cm W.90 cm with burnished legs, talc white bedside table H.47.7 cm W.60 cm with white legs, ash elm chest of drawers W.150 cm with white legs, opus concrete drawer chests W.45 cm with burnished legs.



Trend isola comò

Isola comò L.122,4 cm ottanio top vetro lucido brunito.
Octane, double-sided chest of drawers W.122.4 cm with glossy burnished glass top.



Gap

Complementi Gap comodino H.47,7 cm L.60 cm selce, comodino H.29,3 cm L.90 cm cashmere, comò L.120 cm cashmere, settimanale L.60 cm rovere natural.
Gap complementary furniture: flint bedside table H.47.7 cm W.60 cm, cashmere bedside table H.29.3 cm W.90 cm, cashmere chest of drawers W.120 cm, natural oak chest of drawers W.60 cm.



Grip

Complementi Grip: comodino H.38,5 cm L.90 cm opus mattone con profili opus mattone, comodino H.47,7 cm L.45 cm cashmere con profili cashmere e top vetro cashmere, comò L.120 cm selce con profili brunito, settimanale L.45 cm lignum dark con profili brunito.
Grip complementary furniture: opus brick bedside table H.38.5 cm W.90 cm with opus brick profiles, cashmere bedside table H.47.7 cm W.45 cm with cashmere profiles and cashmere glass top, flint chest of drawers W.120 cm with burnished profiles, lignum dark chest of drawers W.45 cm with burnished profiles.



Frame

Complementi Frame comodini H.30,5 cm L.47,4 cm e H.48,9 cm L.47,4 cm bianco talco, comodino H.39,7 cm L.92,4 cm ottanio, comò L.122,4 cm opus cemento, settimanale L.92,4 cm ardesia.
Frame complementary furniture: talc white bedside tables H.30.5 cm W.47.4 cm and H.48.9 cm W.47.4 cm, octane bedside table H.39.7 cm W.92.4 cm, opus concrete chest of drawers W.122.4 cm, slate chest of drawers W.92.4 cm.

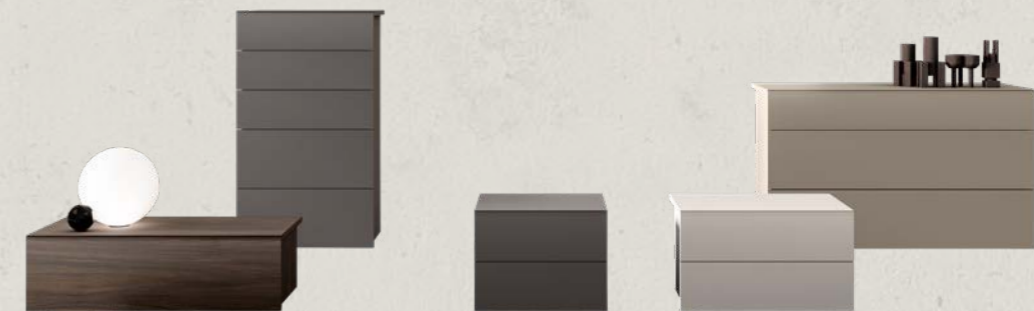

Set

Complementi Set: comodino H.29,7 cm L.94 cm lignum dark, comodino H.38,9 cm L.49 cm ardesia, comodino H.38,9 cm L.64 cm pomice, comò L.124 cm arena, settimanale L.64 cm ardesia.
Set complementary furniture: lignum dark bedside table H.29.7 cm W.94 cm, slate bedside table H.38.9 cm W.49 cm, pumice bedside table H.38.9 cm W.64 cm, arena chest of drawers W.124 cm, slate chest of drawers W.64 cm.



Simply

Complementi Simply: comodini H.39,7 cm L.60 cm e L.90 cm opus mattone e noce, comò L.120 cm noce, settimanali L.45 cm pomice.
Simply complementary furniture: opus brick and walnut bedside tables H.39.7 cm W.60 cm and W.90 cm, walnut chest of drawers W.120 cm, pumice chest of drawers W.45 cm.



Tic | Tac

Complementi Tic tavolino H.48,9 cm L.50 cm lignum dark gambe brunito, tavolino H.30,4 cm L.90 cm ardesia gambe brunito; Complementi Tac H.48,9 cm Ø50 cm pomice gambe bianco, opus mattone gambe brunito.
Tic complementary furniture: lignum dark side table H.48.9 cm W.50 cm with burnished legs, slate side table H.21.3 cm W.90 cm with burnished legs. Tac complementary furniture: side tables H.48.9 cm Ø50 cm in pumice with white legs and in opus brick with burnished legs.



Raster

Complementi Raster: comodini H.30,5 cm L.60 cm e H.39,7 cm L.45 cm cashmere, comò L.150 cm selce, settimanale L.60 cm olmo ash.
Raster complementary furniture: cashmere bedside tables H.30.5 cm W.60 and H.39.7 cm W.45 cm, flint chest of drawers W.150 cm, ash elm chest of drawers W.60 cm.

YOUNG



SM2512

Sistema a cremagliera Flexy Easy con montanti e reggimensole brunito, mensole ottanio, contenitori cassetti Grip ottanio profilo brunito; armadio battente Alterna con cassetti Grip e anta Gola opus mattone profilo opus mattone, terminale libreria opus mattone, interni sesamo. Mensola Marker brunito.
Flexy Easy rack system with burnished racks and shelf brackets, octane shelves, Grip octane drawer unit with burnished profile; Alterna hinged wardrobe with Grip drawers and Gola door with opus brick profile, opus brick end bookcase and sesame interiors. Marker burnished shelf.



SM2509

Armadio battente Gola con modulo tv, angolo lineare e terminale libreria, struttura e profili ottanio, interno sesamo. Pannello testata imbottito Pollock rovere natural e tessuto Funny S51, contenitore su testata Gap rovere natural; vassoio portaoggetti in metallo ottanio, giroletto contenitore H.29 cm opus calce. *Gola hinged door wardrobe with TV module, linear corner and end bookcase, octane structure and profiles, sesame interior finish. Pollock natural oak headboard upholstered with Funny S51 fabric, storage unit on Gap natural oak headboard; tidy tray in octane metal, H. 29cm storage bed frame, opus lime finish.*



SM2511



Armadio battente Alterna con anta Plana pomice, maniglia Bench selce, modulo ponte pomice, pannello e scrittoio sotto ponte selce, terminale con appendino. Letto Tablet rovere natural con cuffia Klee tessuto Creta C09. Sistema a spalla Freespace con modulo bifacciale selce, ante battenti Plana maniglia Roll brunito; divisori ed elementi a C rovere natural. Alterna wardrobe with Plana pumice hinged door, Bench flint handle. Pumice overhead module, flint panel and desk under overhead module, end unit with clothes rack. Tablet bed natural oak shaped panel with Klee headboard quilt in Creta C09 fabric. Freespace flint, double-faced load-bearing panel system, Plana hinged doors, Roll burnished handled; natural oak partitions and C-shaped elements.

SM2514

Armadio battente anta Plana con maniglia Inclina bianco talco, interni sesamo, modulo angolo spogliatoio, modulo letto a ribalta, terminale sagomato con appendino bianco talco e libreria di collegamento ottanio.

Plana hinged wardrobe with Inclina talc white handle, sesame interiors, corner closet module, fold-away bed module, talc white shaped end unit with clothes rack and octane linking bookcase.



SM2507



Armadio contenitore con modulo ponte sospeso; esterno, interno e anta Plana opus cemento, maniglia Virgola ardesia. Scrivitoio sp.5 cm rovere natural, mensole Marker bianco e pensili Unoedue. Testata contenitore e giroletto Light con rete estraibile manuale rovere natural. Storage wardrobe with wall-hung overhead module; opus concrete interior, exterior finish and Plana doors, slate Virgola handle. Natural oak 5 cm thick desk, white Marker shelves, Unoedue wall units. Storage headboard and Light bed frame with natural oak manual pull-out bed base.

SM2550



Cabina Free con interni in noce, chiusura battente ante Mixer e ante di finitura retro pomice. Mensole Marker in metallo bianco. Letto Soft testata imbottita tessuto Smack S14, giroletto H.19 cm con taglio 45° in noce, gambe Ruler brunito. Comodino Speed noce, maniglia brunito. Sistema a spalla sospeso Freespace pomice, scrittoio sospeso noce. Sedia Kanvas struttura e scocca bianco. Free closet with walnut interiors, Mixer hinged doors and pumice rear finishing door. Marker white metal shelf. Soft bed, headboard upholstered with Smack S14 fabric, H.19 cm walnut bed frame with 45° inclined edge, Ruler burnished legs. Speed walnut bedside table, burnished handle. Freespace pumice suspended load-bearing panel system, suspended walnut desk. Kanvas chair with white base and shell.

SM2551

Armadio Alterna battente anta Gola bianco talco, profilo ardesia, interni sesamo. Sistema a spalla Freespace, moduli a terra bifacciali ardesia con elementi divisori e a C rovere natural, moduli sospesi bianco talco con schiene bianco talco e rovere natural. Pannello testata imbottito ardesia tessuto Frisby A10, giroletto bianco talco unione a 45°, comodino Simply bianco talco. Scrivitoio Compasso con piano bianco talco e gambe metallo bianco, screen imbottito tessuto Frisby A10, sedia Bloom struttura e scocca bianco, cuscino tessuto Creta C1F. Alterna hinged wardrobe with Gola talc white door, slate profile, sesame interiors. Freespace load-bearing panel system, slate double-faced floor-standing modules with partitions and natural oak C-shaped elements, talc white suspended modules with talc white and natural oak back panels. Slate headboard panel upholstered with Frisby A10 fabric, talc white bed frame with 45° joint, Simply talc white bedside table. Compasso desk with talc white top and white metal legs, upholstered screen in Frisby A10 fabric, Bloom chair with white base and shell, cushion in Creta C1F fabric.





SM2528

Armadio battente anta Plana e maniglia tipo M bianco talco. Modulo ponte con terminali sottoponte rovere natural. Letto imbottito Luk Small una piazza e mezza, tessuto Funny S51, piedini Ruler bianco talco. Scrivitoio Scriba con piano bianco talco e gambe metallo bianco, sedia Set struttura e scocca bianco. *Hinged door wardrobe with Plana doors and talc white M handle. Natural oak overhead module with end modules below. Upholstered queen-sized Luk Small bed, Funny S51 fabric, talc white Ruler feet. Scriba desk with talc white top and white metal legs, Set chair with white base and shell.*



SM2552



Letto Slim imbottito tessuto Funny S64, comodino Lucky olmo ash struttura in metallo bianco; contenitori Vuotopieno struttura ardesia, ante olmo ash. Scrivitoio sagomato sp.2,8 cm olmo ash, moduli libreria Freespace a terra ardesia, sedia Fuller in metallo bianco.
Slim bed upholstered with Funny S64 fabric, Lucky elm ash bedside table, white metal carcass; Vuotopieno storage units with slate carcass and elm ash doors. 2.8cm thick elm ash shaped desk, Freespace floor-standing, slate bookcase modules, Fuller white metal chair.

SM2529



Letto matrimoniale con pannelli testata opus cemento, testata imbottita e giroletto imbottito H.19 cm tessuto Smack S13. Scrivitoio sagomato angolare sp.2,8 cm con cassetiera ottanio. Pensili anta Plana push&pull ottanio e Unoedue opus cemento a giorno. Armadio battente anta Plana push&pull pomice, modulo con nicchia opus cemento, ante plana pomice. Hinged door wardrobe with pumice Plana push&pull doors, opus concrete niche module, pumice Plana doors. Double bed with opus concrete headboard panels, upholstered headboard and H.19 cm bed frame upholstered in Smack S13 fabric. Corner shaped, 2.8 cm thick desk with octane drawer unit. Wall units with octane Plana push&pull doors and opus concrete Unoedue open wall units. Hinged door wardrobe with pumice Plana push&pull doors, opus concrete niche module, pumice Plana doors.

SM2553



Sistema a palo Windy a parete e a soffitto con mensole sp.2,8 cm, piano scrittoio sp.5 cm, contenitori anta vasistas e anta ribalta Plana rovere natural, maniglie Lallas brunito. Pannelli Siparium con tasche porta oggetti tessuto Smack S09, giroletto singolo H.9 cm con gamba R30 arena. Tavolino Tac con struttura in metallo brunito e piano in melaminico arena. Armadio scorrevole anta Mixer e profilo arena, interni sesamo. Windy wall and ceiling pole system with 2.8cm thick shelves, 5cm thick desk, storage units with lift-up door and Plana natural oak drop-down door, Lallas burnished handle. Siparium panels with pockets in Smack S09 fabric, H. 9cm single bed frame with R30 arena leg. Tac coffee table with burnished metal carcass and arena melamine top. Sliding wardrobe with Mixer door and arena profile, sesame interiors.



SM2555

Armadio battente anta Plana maniglia Ruler ottanio con modulo angolo spogliatoio interni sesamo, modulo ponte con pannelli e mensola sottoponte in noce. Sistema a spalla Freespace pomice, nicchia in noce con specchio. Pensili e basi Z45 ottanio e pomice, scrittoio sp.5 cm in noce. Sedia Strato tessuto Creta C41. Letto Luk Small tessuto Creta C1F, gambe Raked pomice.
Hinged wardrobe with Plana door, Ruler octane handle with corner closet module, sesame interiors, overhead module with walnut panels and shelf under overhead module. Freespace pumice load-bearing panel system, walnut niche with mirror. Z45 octane and pumice wall and base units, 5cm thick walnut desk. Strato chair in Creta C41 fabric. Luk Small bed, Creta C1F fabric, Raked pumice legs.

SM2554

Pannelli imbottiti Labyrinth tessuto Creta C33 tasca porta oggetti e giroletti imbottiti H.32 cm tessuto Frisby A12. Armadio battente anta Ciak cashmere. Sistema Flexy con pannello opus mattone e mensole cashmere. Tavolino Tic struttura brunito piano opus mattone, comodino Speed cashmere maniglia bianco. Pensili Unoedue opus mattone, mensola Marker bianco. Scrittoio con cassetiera cashmere, sedie Compass. *Labyrinth panels upholstered with Creta C33 fabric, pocket and H.32cm upholstered bed frame in Frisby A12 fabric. Hinged wardrobe with Ciak cashmere door. Flexy system with opus brick panel and cashmere shelves. Tic coffee table, burnished frame, opus brick top, Speed cashmere bedside table, white handle. Unoedue opus brick wall units, Marker white shelf. Desk with cashmere drawer unit, Compass chairs.*



SM2530

Pannelli imbottiti Labyrinth tessuto Creta C01 e Smack S12 con tasca porta oggetti Smack S12. Turchetta Light con cassetti selce. Tavolino Tac struttura brunito piano selce. Armadio battente anta Grip e basi armadio con cassetti Grip opus calce e profilo brunito. Sistema a cremagliera Flexy Easy con montanti e reggimensole brunito, mensole opus calce. Pensili a giorno opus calce, scrittoio sp.5 cm con cassettiera selce, sedia Kanvas scocca pistacchio e struttura nero. *Labyrinth panels upholstered in Creta C01 and Smack S12 fabric with a Smack S12 accessory pocket. Turchetta Light with flint drawers. Tac side table with burnished structure and flint top. Hinged door wardrobe with Grip doors and wardrobe base units with opus lime Grip drawers and burnished profile. Flexy Easy rack system with burnished metal parts and shelf brackets, opus lime shelves. Opus lime open wall units, 5 cm thick desk with flint drawer unit, Kanvas chair with pistachio body and black structure.*



Letti Beds



Decor

Letto imbottito Decor testata con decoro, giroletto H.12 cm, gambe in metallo Raked, Topper o Ruler. Nell'immagine letto Decor in tessuto Funny S65, gamba Raked in metallo brunito. *Decor upholstered bed with decorated headboard, H.12cm bed frame, Raked, Topper or Ruler metal legs. Image shows Decor bed in Funny S65 fabric, Raked burnished metal leg.*



Blunt

Letto imbottito con testata e giroletto H.12 cm con unione a 45°, gambe in metallo Raked, Topper o Ruler. Nell'immagine letto Blunt in tessuto Creta C09 gambe Raked bianco. *Upholstered bed with headboard and H.12cm bed frame with 45° joint, Raked, Topper or Ruler metal legs. Image shows Blunt bed in Creta C09 fabric, white Raked legs.*



Spoon

Letto imbottito con testata dalla forma sinuosa e giroletto H.19 cm, gambe in metallo Topper, Raked o Ruler. Nell'immagine letto imbottito Spoon tessuto Frisby A10 gambe Topper brunito. *Upholstered bed with sinuous headboard and H.19cm bed frame, Topper, Raked or Ruler metal legs. Image shows Spoon upholstered bed in Frisby A10 fabric, burnished Topper legs.*



Slim

Letto imbottito con testata dalla leggera curvatura e giroletto H.29 cm. Nell'immagine letto imbottito Slim, tessuto Frisby A07. *Upholstered bed with slightly curved headboard and H.29cm bed frame. Image shows Slim upholstered bed in Frisby A07 fabric.*



Luk Small | Luk Big

Letto imbottito Luk Small con testata H.94 cm, Luk Big con testata H.112 cm, giroletto H.19 cm e gambe in metallo Topper, Raked o Ruler. Nell'immagine letto Luk Small tessuto Funny S64 gambe Raked brunito. *Luk Small upholstered bed with H.94cm headboard, Luk Big upholstered bed with H.94cm headboard, H.19cm bed frame and Topper, Raked or Ruler metal legs. Image shows Luk Small bed in Funny S64 fabric, Raked burnished legs.*



Icon Small | Icon Big

Letto imbottito Icon Small con testata H.92 cm, Icon Big con testata H.110 cm caratterizzate da un particolare disegno, giroletto H.29 cm. Nell'immagine letto imbottito Icon Small tessuto Frisby A04. *Icon Small upholstered bed with H.92cm headboard, Icon Big upholstered bed with H.110cm headboard, featuring a special pattern, H.29cm bed frame. Image shows Icon Small upholstered bed in Frisby A04 fabric.*



Contenitore

Letto contenitore imbottito H. 92 cm per angolo. Nell'immagine letto contenitore imbottito tessuto Smack S13. *Upholstered bed with storage unit H. 92 cm for a corner. Image shows a bed with storage unit upholstered in Smack S13 fabric.*



Giroletti imbottiti Upholstered bed frames

Giroletto imbottito H.32 cm con box contenitore opzionale. Nell'immagine giroletto imbottito L.135 cm in tessuto Funny S61, testata con 2 pannelli centrali distanziati L.135 cm e 2 pannelli laterali L.90 cm H.111,4 cm ardesia, comodino Gap L.45 H.38,5 ardesia. *H.32cm upholstered bed frame with optional lift-up storage. Image shows L.135cm upholstered bed frame in Funny S61 fabric, headboard with 2 x L.135cm central panels with spacer and 2 x L.90cm H.111.4cm slate side panels, Gap slate bedside table L.45 H.38.5.*



Soft

Testata imbottita sp.7 cm rivestita in tessuto o ecopelle sfoderabile, combinabile con tutti i giroletti. Nell'immagine letto Soft testata tessuto Frisby A07 giroletto H.19 noce gambe Ruler brunito.
7cm thick upholstered headboard with fabric or eco-leather removable cover, to combine with all bed frames. Image shows Soft bed with headboard in Frisby A07 fabric, H.19 walnut bed frame, Ruler burnished legs.



Wing

Testata imbottita sp.7 cm rivestita in tessuto o ecopelle sfoderabile, combinabile con tutti i giroletti. Nell'immagine letto Wing con testata tessuto C1F giroletto R30 cashmere gamba Raked cashmere.
7cm thick upholstered headboard with fabric or eco-leather removable cover, to combine with all bed frames. Image shows Wing bed with headboard in C1F fabric, R30 cashmere bed frame, Raked cashmere legs.



Bent

Testata curva sp.2,2 cm pannello sagomato in nobilitato, combinabile con tutti i giroletti, copertura per testata in tessuto trapuntato opzionale. Nell'immagine letto Bent pomice giroletto R30. *2.2cm thick melamine faced panel for curved headboard to combine with all bed frames, optional quilted fabric headboard cover. Image shows Bent pumice bed, R30 bed frame.*



Fold

Testata inclinata sp.2,2 cm con angoli raggiati con due pannelli in nobilitato, combinabile con tutti i giroletti, copertura per testata in tessuto trapuntato opzionale. Nell'immagine letto Fold ottanio giroletto gamba 45. *2.2cm thick inclined headboard with radial corners and two melamine faced panels, to combine with all bed frames, optional quilted fabric headboard cover. Image shows Fold bed, octane bed frame, 45 legs.*



Tablet

Testata sp.2,2 cm pannello sagomato in nobilitato, combinabile con tutti i giroletti, copertura per testata in tessuto trapuntato opzionale. Nell'immagine letto Tablet testata e giroletto H.29 cm contenitore cashmere cuffia Klee Funny S61. *2.2cm thick shaped melamine faced panel, to combine with all bed frames, optional quilted fabric cover. Image shows Tablet bed with H.29cm bed frame, cashmere storage unit, Klee Funny S61 fabric slipcover.*



Light

Letto Light disponibile in differenti versioni: sommier, con testiera, con giroletto attrezzabile, con meccanismo laterale o con piedini. Testiera e pediera e longoni sp.2,8 cm. Nell'immagine letto Light H.38 cm con coppia di cassetti estraibili ottanio. *Light bed available in various versions: sofa bed, with a headboard, with an accessorised bed frame, with a side mechanism or with feet. 2.8 cm thick headboard, footboard and bed side panels. Image shows Light bed, H.38 cm, with a pair of octane pull-out drawers.*



Radius

Letto Radius disponibile in differenti versioni: sommier, con testiera, con giroletto attrezzabile, con meccanismo laterale o con piedini. Testiera e pediera con raggiatura sp.2,8 cm e longoni sp.2,8 cm. Nell'immagine letto Radius H.92 cm con rete estraibile rovere natural. *Radius bed available in various versions: sofa bed, with a headboard, with an accessorised bed frame, with a side mechanism or with feet. 2.8 cm thick rounded headboard and footboard and 2.8 cm thick bed side panels. Image shows Radius bed H.92 cm with natural oak pull-out bed base.*



Giroletti *Bed frames*

Giroletti in melaminico in diverse varianti di altezza e di giunzione tra longone e pediera, disponibili con tutti i tipi di gambe. Nell'immagine giroletto H.29 cm con unione a 45°, pannello testata imbottito ottanio e tessuto Creta C09, comodino pensile Frame L.47,4 H.19,6 bianco talco.

Melamine bed frames in several variants for height and side and footboard joint, with any of the leg types available. Image shows H.29cm bed frame with 45° joint, headboard panel upholstered in octane Creta C09 fabric, Frame talc white suspended bedside table L.47.4 H.19.6.



Pannelli testate *Headboard panels*

Pannelli sp.1,8 cm sospesi o a terra disponibili in diverse varianti e misure, con accessori da aggancio e lampade Led opzionali, combinabili con tutti i giroletti. Nell'immagine letto con testata a terra rovere natural 1 pannello centrale L.135 cm e 2 pannelli laterali L.90 cm H.111,4 cm rovere natural, giroletto H.19 cm imbottito tessuto Smack S03 gambe Topper selce tavolino Tac struttura brunito e piano selce.

1.8cm thick panels, suspended or floor-standing, available in several variants and sizes, with optional hanging accessories and LED lamps, to combine with all bed frames. Image shows bed with natural oak floor-standing headboard, 1 x L.135cm central panel and 2 x L.90cm H.111.4cm natural oak side panels, H.19cm upholstered bed frame in Smack S03 fabric, Topper flint legs, Tac coffee table with burnished frame and flint top.

Letti a castello *Bunk beds*



Letto a castello con testiera, pediera, longoni e giroletto sp.2.8cm, schienale sp 1,8 cm. Protezioni (fisse o reclinabili) e scaletta in bianco talco o brunito. Nelle immagini letto a castello singolo finitura ottanio con scaletta e protezione brunito, libreria Freespace a terra con scrittoio sp 2.8 cm in appoggio. Letto a castello doppio finitura bianco talco con scaletta e protezione bianco talco. Coppia di cassetti estraibili ardesia.

Bunk bed with 2.8 cm thick headboard, footboard, bed side panels and bed frame, 1.8 cm thick back panel. Safety guards (fixed or tilting) and talc white or burnished ladder. Images show single bunk bed with octane finish, with burnished ladder and safety guard, floor-level Freespace bookcase with 2.8 cm thick desk resting on it. Double bunk bed with talc white finish, with talc white ladder and safety guard. Pair of slate pull-out drawers.

Letti a ribalta *Folding bed*



Inquadra il QR Code per specifiche
sui sistemi di apertura
*Scan the QR Code for specifications
regarding opening systems*



Freespace

Modulo letto a ribalta disponibile in tre misure: L. 100,5 (rete L. 90x200) L. 130,5 (rete L. 120x200) e L. 170,5 (rete L. 160x200) e in due altezze 222,4 o 259,2.
Folding bed module available in three sizes: L. 100.5 (bed base L. 90x200) L. 130.5 (bed base L. 120x200) and L. 170.5 (bed base L. 160x200) and two heights 222.4 or 259.2.

Freespace

Modulo letto a ribalta orizzontale e modulo letto a ribalta a castello orizzontale disponibili in misura: L. 208,5 (rete L. 90x200) e in tre altezze 185,6, 222,4 o 259,2.
Horizontal folding bed module and horizontal folding bunk bed module available in one length: L. 208.5 (bed base L. 90x200) and three heights 185.6, 222.4 or 259.2.

Scrittoi Desks



Compasso

Scrittoio con piano in melaminico sp.2,8 cm in: bianco talco, pomice, cashmere, arena, selce, ottanio, ardesia, olmo ash, rovere natural, noce, lignum dark, opus calce, opus cemento, opus mattone. Gambe di sostegno metalliche finitura bianco talco e brunito. Screen opzionale. *Desk with 2.8cm thick melamine top available in talc white, pumice, cashmere, arena, flint, octane, slate, elm ash, natural oak, walnut, lignum dark, opus lime, opus concrete, opus brick. Metal legs available talc white or burnished. Optional screen.*



Scriba

Scrittoio con piano in melaminico sp.1,8 cm disponibile in: bianco talco, pomice, cashmere, arena, selce, ottanio, ardesia, olmo ash, rovere natural, noce, lignum dark, opus calce, opus cemento, opus mattone. Gambe in metallo finitura bianco talco. *Desk with 1.8cm thick melamine top available in talc white, pumice, cashmere, arena, flint, octane, slate, elm ash, natural oak, walnut, lignum dark, opus lime, opus concrete, opus brick. Talc white metal legs.*



Gamba 10x2

Scrittoio con piano in melaminico sp.2,8 cm disponibile in: bianco talco, pomice, cashmere, arena, selce, ottanio, ardesia, olmo ash, rovere natural, noce, lignum dark, opus calce, opus cemento, opus mattone. Gambe in metallo nelle finiture: bianco talco, pomice, cashmere, arena, selce, ottanio, ardesia e brunito. *Desk with 2.8cm thick melamine top available in talc white, pumice, cashmere, arena, flint, octane, slate, elm ash, natural oak, walnut, lignum dark, opus lime, opus concrete, opus brick. Metal legs in talc white, pumice, cashmere, arena, flint, octane, slate, burnished.*



Archimede

Scrittoio con piano in melaminico sp.1,8 cm disponibile in: bianco talco, pomice, cashmere, arena, selce, ottanio, ardesia, olmo ash, rovere natural, noce, lignum dark, opus calce, opus cemento, opus mattone. Gambe in metallo finitura bianco talco. *Desk with 1.8cm thick melamine top available in talc white, pumice, cashmere, arena, flint, octane, slate, elm ash, natural oak, walnut, lignum dark, opus lime, opus concrete, opus brick. Talc white metal legs.*



Sign

Scrittoio con struttura metallica sezione di 1,8x1 cm in bianco talco o brunito. Piedino in acciaio regolabile Ø2,8 cm. Piano in melaminico sp.1,8 cm in bianco talco, pomice, cashmere, arena, selce, ottanio, ardesia, olmo ash, rovere natural, noce, lignum dark, opus calce, opus cemento, opus mattone, e in vetro temperato sp.1,2 cm con vetro lucido o opaco bianco talco o brunito. Screen opzionale. *Desk with 1.8x1cm section talc white or burnished metal frame. Ø 2.8 cm adjustable steel legs. 1.8 thick melamine top available in: talc white, pumice, cashmere, arena, flint, octane, slate, elm ash, natural oak, walnut, lignum dark, opus lime, opus concrete, opus brick or in 1.2cm thick toughened glass with talc white or burnished glossy or matt finish. Optional screen.*



Scrittoio sospeso

Scrittoio sospeso sp.5 cm disponibile in altezza H.36,8 cm e H.46 cm, profondità 45,5 cm e 61,5 cm. Finiture: bianco talco, pomice, cashmere, arena, selce, ottanio, ardesia, olmo ash, rovere natural, noce, lignum dark, opus calce, opus cemento, opus mattone. *Suspended 5cm thick desk available in heights H.36.8cm and H.46cm, depths 45.5cm and 61.5cm. Finishes: talc white, pumice, cashmere, arena, flint, octane, slate, elm ash, natural oak, walnut, lignum dark, opus lime, opus concrete, opus brick.*



Scrittoio sp.5

Scrittoio con gambe e piano in melaminico sp.5 cm disponibile in due profondità 61,5 cm e 70 cm. Finiture: bianco talco, pomice, cashmere, arena, selce, ottanio, ardesia, olmo ash, rovere natural, noce, lignum dark, opus calce, opus cemento, opus mattone. *Desk with 5cm thick melamine legs and top, available in two depths 61.5cm and 70cm. Finishes: talc white, pumice, cashmere, arena, flint, octane, slate, elm ash, natural oak, walnut, lignum dark, opus lime, opus concrete, opus brick.*

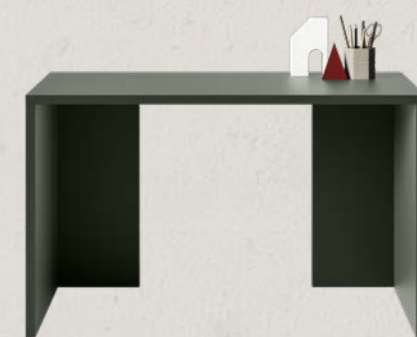

Gamba Elle

Scrittoio con gambe ad L piano in melaminico sp.2,8 cm disponibile in profondità 61,5 cm. Finiture: bianco talco, pomice, cashmere, arena, selce, ottanio, ardesia, olmo ash, rovere natural, noce, lignum dark, opus calce, opus cemento, opus mattone. *Desk with L-shaped legs and 2.8cm thick melamine top, available in depth 61.5cm. Finishes: talc white, pumice, cashmere, arena, flint, octane, slate, elm ash, natural oak, walnut, lignum dark, opus lime, opus concrete, opus brick.*

Sedie Chairs



Set

Sedia con struttura in metallo verniciata bianca, sedile e schienale in polipropilene disponibile nelle finiture bianco e tortora. Regolazione in altezza a gas e base girevole su ruote piroettanti gommate anti-traccia. *Chair with white painted metal structure, polypropylene seat and back available in the finishes: white and dove grey. Gas-lift adjustable height and swivel base on rubber, non-marking swivel castors.*



Elipse

Sedia con scocca in plastica disponibile nelle finiture: bianco, tortora e grigio. Base in acciaio verniciato bianco, regolazione in altezza a gas e ruote gommate anti-traccia. *Chair with plastic body available in the finishes: white, dove grey and grey. White painted steel base, gas-lift adjustable height and rubber, non-marking castors.*



Well

Sedia con scocca in polipropilene disponibile nelle finiture bianco e tortora, struttura in metallo verniciata bianca girevole su ruote piroettanti gommate anti-traccia, regolazione in altezza a gas. *Chair with polypropylene body available in the finishes: white and dove grey; white painted metal swivel structure on rubber, non-marking swivel castors, gas-lift adjustable height.*



Conic

Sedia con struttura in metallo, scocca in polipropilene, regolazione in altezza a gas e base girevole su ruote piroettanti gommate anti-traccia, cuscino rivestito in ecopelle. Scocca e struttura disponibili in bianco, cuscino in ecopelle nelle finiture: bianco, grigio chiaro, grigio scuro, tortora, testa di moro. *Chair with polypropylene shell, metal structure with gas-lift adjustable height, on rubber, non-marking swivel castors, cushion with eco-leather cover. Shell and structure available in white, eco-leather cushion in white, light grey, dark grey, dove grey or dark brown.*



Strato

Sedia con struttura in metallo verniciata bianca, sedile/schiena imbottito rivestito in tessuto sfoderabile, regolazione in altezza a gas e ruote piroettanti gommate anti-traccia. Rivestimento disponibile in tutti i tessuti. *Chair with white painted metal structure, padded seat/backrest with removable fabric covers, gas-lift height adjustable and rubber, non-marking swivel castors. Covers available in any of our fabrics.*



Bloom

Sedia con scocca in materiale plastico e base in metallo verniciata bianca girevole su ruote piroettanti gommate anti-traccia, regolazione in altezza a gas. Scocca disponibile in finitura bianco, selce, nero. Cuscino opzionale disponibile in tutti i tessuti. *Chair with plastic shell and white painted metal base with gas-lift adjustable height, on rubber, non-marking swivel castors. Shell available in white, flint or black. Optional cushion available in any of our fabrics.*



Poli | Poli imbottita

Sedia con scocca in polipropilene; cuscino e schienale imbottiti rivestiti in tessuto; base in acciaio verniciato bianco, regolazione in altezza a gas e ruote piroettanti gommate anti-traccia. Scocca disponibile in finitura bianco. Rivestimento nei colori: grigio e nero. *Chair with polypropylene structure; fabric upholstered cushion and backrest; base in white painted steel, gas-lift adjustable height, on rubber, non-marking swivel castors. Shell available in white. Upholstery in grey or black.*



Vela

Sedia in polipropilene con struttura e schienale in colore bianco e sedile rivestito in tessuto, regolazione in altezza a gas e ruote piroettanti gommate anti-traccia. Rivestimento disponibile in tutti i tessuti. *Polypropylene chair with structure and back in the colour white and seat upholstered in fabric, gas-lift adjustable height and rubber, non-marking swivel castors. Upholstery available in all fabrics.*

SYSTEMS AND FITTINGS

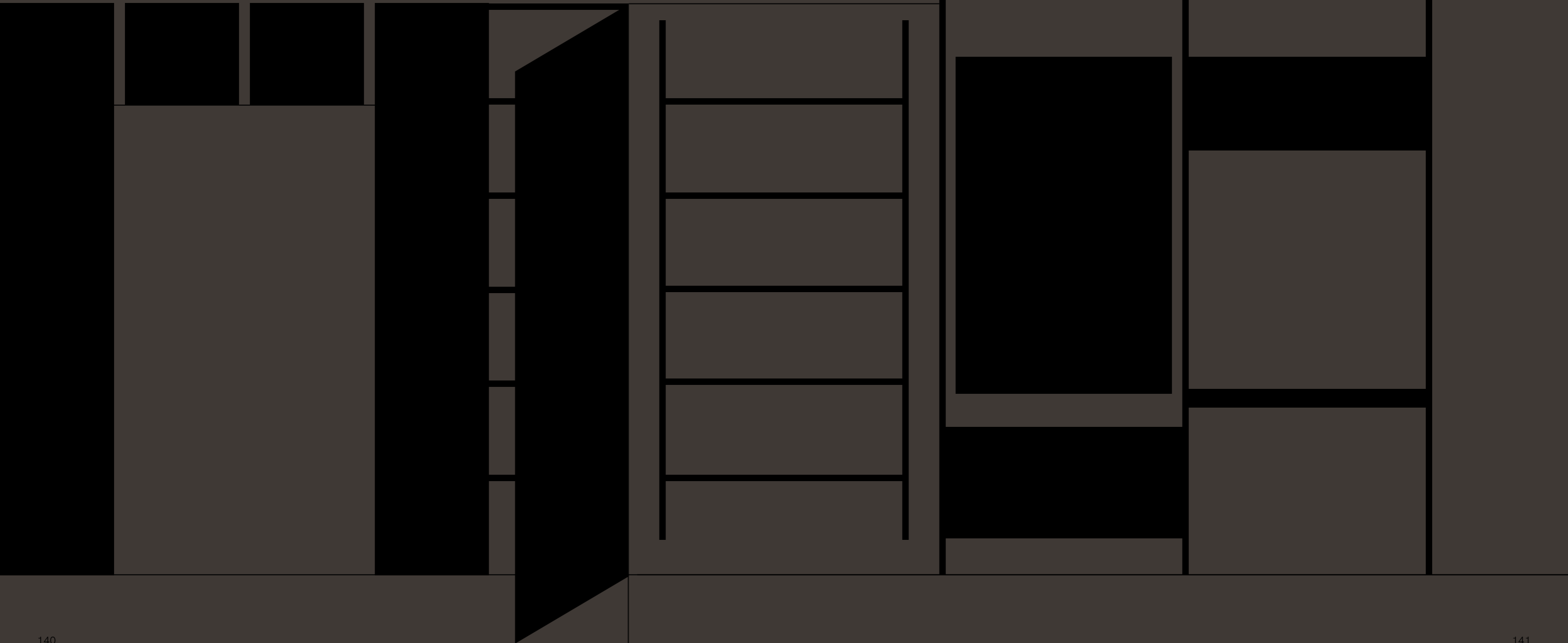

Storage units



1. Vuotopieno pensili con unione a 45° e ante asimmetriche. *Vuotopieno wall units with 45° joints and asymmetric fronts.* **2. Base** in appoggio anta battente Plana maniglia Roll, fianchi e cappelli sp.18 mm. *Elevated base units with Plana hinged doors, Roll handles, 18 mm thick side and top panels.* **3. Pensili** fianchi e cappelli sp.18 mm anta battente City Glass. *Wall units with 18 mm thick side and top panels, City Glass hinged door.* **4. Base** a terra con vassoio anta ribalta Plana push&pull fianchi e cappelli sp.18 mm. *Floor-level base unit with tray, Plana push&pull drop-down door and 18 mm thick sides and top panels.* **5. Z45** pensili con unione a 45° anta a ribalta e vasistas Plana. *Z45 wall units with 45° joints and Plana drop-down and lift-up doors.* **6. Z45** base sospesa con unione a 45° anta a ribalta Plana push&pull. *Z45 wall-hung base unit with 45° joints and Plana push&pull drop-down door.* **7. Unoedue** pensili con fianchi e cappelli sp.12 mm. *Unoedue wall units with 12 mm thick side and top panels.* **8. Unoedue** base sospesa con fianchi e cappelli sp.12 mm. *Unoedue wall-hung base unit with 12 mm thick side and top panels.* **9. Base** sospesa anta Grip, fianchi e cappelli sp.18 mm. *Wall-hung base unit with Grip door, 18 mm thick side and top panels.* **10. Pensili** fianchi e cappelli sp.18 mm a giorno e con anta battente Gola. *Wall units with 18 mm thick side and top panels, one open and one with a Gola hinged door.*

basi base units

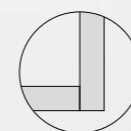

sp.18 mm
18 mm thick

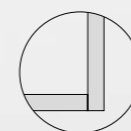

UNOEDUE
basi sp.12 mm
base unit with
12 mm thick

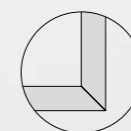

Z45
basi unione 45°
base unit with 45°
joints

pensili wall units



sp.18 mm
18 mm thick



UNOEDUE
pensili sp.12 mm
wall unit with
12 mm thick



Z45
pensili unione 45°
wall unit
with 45° joints

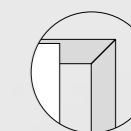

VUOTOPIENO
pensili unione 45°
ante asimmetriche
wall units with
45° joints and
asymmetric fronts

Freespace



1. Terminale sospeso. *Wall-hung end unit.* 2. Modulo sospeso. *Wall-hung module.* 3. Modulo in appoggio. *Sit-on module.* 4. Modulo a terra. *Floor-level module.* 5. Nicchia monofacciale. *Single-sided niche.* 6. Modulo tv a terra con vano a giorno. *Floor-level TV module with open compartment.* 7. Elementi divisori e a C monofacciali. *Dividers and single-sided C-shaped elements.* 8. Scala in metallo. *Metal ladder.* 9. Modulo letto a ribalta con divano. *Wall bed module with sofa.* 10. Angolo aperto. *Open corner unit.* 11. Nicchia ad angolo. *Corner niche.* 12. Tramezza sp.28 mm. *28 mm thick partition.* 13. Modulo angolo bifacciale. *Double-sided corner module.* 14. Modulo a terra bifacciale. *Double-sided floor-level module.* 15. Ponte bifacciale. *Double-sided overhead unit.* 16. Nicchia bifacciale. *Double-sided open niche.*

Freespace

Modulo letto a ribalta con divano
Fold-away bed module with sofa



Modulo letto a ribalta con divano bracciolo sp.3 cm oppure sp.15 cm disponibile in due misure:
L.130,5 (rete L.120x200) e L.170,5 (rete L.160x200) e in due altezze 222,4 o 259,2; ai lati elementi a giorno.
*Folding bed module with sofa featuring 3 cm or 15 cm wide armrests, available in two sizes: W.130.5
(bed base W.120x200) and W.170.5 (bed base W.160x200) and in two heights 222.4 or 259.2. Flanked by open units.*



Inquadra il QR Code per specifiche
sui sistemi di apertura
*Scan the QR Code for specifications
regarding opening systems*

Modulor



1. Mensola in metallo. *Metal shelf.* 2. Scrivania P.45,5. *Desk D.45.5.* 3. Contenitore anta battente City Glass. *Unit with City Glass hinged door.* 4. Contenitore anta battente Plana push&pull. *Unit with Plana push&pull hinged door.* 5. Contenitore anta a ribalta Plana push&pull. *Unit with Plana push&pull drop-down door.* 6. Contenitore anta battente Gola. *Unit with Gola hinged door.* 7. Cassetti Grip. *Grip drawers.* 8. Contenitore anta a ribalta City Glass. *Unit with City Glass drop-down door.*

Flexy Easy



1. Portacamicie. *Shirt shelves.* 2. Mensola portascarpe. *Shoes shelf.* 3. Vassoio Trai 45 frontalino in melaminico. *Trai 45 tray with melamine front.* 4. Contenitore anta battente Gola. *Unit with Gola hinged doors.* 5. Vassoio Trai 45 frontalino in vetro. *Trai 45 tray with glass front.* 6. Cassetti e cassettoni Grip. *Grip drawers and deep drawers.* 7. Vassoio e portapantaloni Trai 45 frontalino in vetro. *Trai 45 tray and trousers rack with glass front.* 8. Ripiano Trai 45 in vetro con appendiabiti. *Trai 45 shelf in glass with hanging rail.* 9. Cassetti Plana maniglia Roll. *Plana drawers with Roll handle.* 10. Mensola P.30. *Shelves D.30.* 11. Contenitore anta ribalta Plana con boccola passacavi. *Unit with Plana bottom-hung door and cable grammet.* 12. Elemento a giorno. *Open unit.* 13. Contenitore anta vasistas City Glass. *Unit with City Glass lift-up door.* 14. Ripiano Trai 45 in vetro. *Trai 45 glass shelf.*

Flexy



1. Servetto. Clothes-lift. 2. Portacamicie. Shirt shelves. 3. Mensola portascarpe. Shoe shelf. 4. Ripiano Trai 45 con appendiabiti. Trai 45 shelf with hanging rail. 5. Vassoio Trai 45 frontalino in melaminico. Trai 45 trays with melamine front. 6. Cassetti anta Plana sospesi e in appoggio. Wall-hung and sit-on drawers with Plana fronts. 7. Contenitore anta vasistas City Glass. Unit with City Glass lift-up door. 8. Ripiani Trai 45. Trai 45 shelves. 9. Contenitore anta battente Plana. Unit with Plana hinged doors. 10. Contenitore anta vasistas Plana. Unit with Plana lift-up door. 11. Contenitore anta battente Gola. Unit with Gola hinged doors. 12. Vassoio e portapantaloni Trai 45 frontalino in vetro. Trai 45 tray and trouser rack with glass front. 13. Mensole con fianchi. Shelves with side panels. 14. Cassetti Grip. Grip drawers.

Alterna

1 2* 3* 4 5 6* 7 8* 9 10* 11 12* 13* 14 15 16 17*



1. Anta ripostiglio. *Utility door.* 2. Moduli sovrapponibili. *Overhead modules.* 3. Modulo elettrodomestici. *Household appliance module.* 4. Modulo TV. *TV module.* 5. Modulo spogliatoio. *Dressing room module.* 6. Modulo libreria. *Bookcase module.* 7. Letto ribalta. *Folding bed.* 8. Ponte con terminale libreria. *Overhead end bookcase module.* 9. Modulo angolo esterno. *Open corner unit.* 10. Armadio con nicchia. *Wardrobe with niche.* 11. Modulo scrittoio. *Desk module.* 12. Basi armadio. *Wardrobe base units.* 13. Angolo. *Corner module.* 14. Sopralzo. *Top unit.* 15. Modulo passaggio. *Doorway module.* 16. Stagionale. *Split-door module.* 17. Terminale libreria. *End bookcase module.*

* Moduli disponibili in diverse profondità
Modules available in various depths

Alterna | Free

Interni e accessori
Interiors and accessories



1 2 3

struttura, schiene e accessori sesamo
sesame carcass, back panels and accessories



4 5 6

struttura sesamo, schiene e accessori noce
sesame carcass, walnut back panels and accessories



7 8 9 10

struttura noce, schiene e accessori sesamo
walnut carcass, sesame back panels and accessories



11 12 13

struttura, schiene e accessori noce
walnut carcass, back panels and accessories

1. Divisorio H.143,35. *Partition H.143.35.* 2. Portapantaloni pieghevole. *Folding trousers rack.* 3. Cassettiera 3 cassetti H.55,2 con maniglia integrata, finitura sesamo. *3-drawer unit with integrated handle, sesame finish, H.55.2.* 4. Specchio orientabile. *Swinging mirror.* 5. Cassettiera 2 cassettoni + 2 cassetti H.92 cm. *Drawer unit with 2 deep drawers + 2 x H. 92cm drawers.* 6. Divisorio H.180,15. *Partition H. 180.15.* 7. Vassoio Square H.10 cm. *Square tray, H. 10cm.* 8. Portapantaloni Square H.5 cm. *Square trousers rack, H. 5cm.* 9. Cassettiera 2 cassetti H.36,8 cm. *2-drawer unit, H.36.8cm.* 10. Ripiano estraibile. *Pull-out shelf.* 11. Ripiano portascarpe estraibile. *Pull-out shoes shelf.* 12. Cassettiera 2 cassettoni H.55,2 cm. *Drawer unit with 2 deep drawers, H. 55.2cm.* 13. Divisorio H.106,55 cm. *Partition H. 106.55cm.*

Labyrinth

Pannelli tessili per organizzare lo spazio liberamente
Fabric panels to organise space



Labyrinth #1

Pannelli Labyrinth S e L in tessuto Smack S10 e pannelli M in tessuto Funny S62, giroletto con gambe a 45° e comodino Frame pomice, scrittoio con gamba a elle e cassettera pomice, sedia Kanvas bianco.

Labyrinth S and L panels in Smack S10 fabric and panels M in Funny S62 fabric, bed frame with 45° legs and Frame pumice bedside table, desk with L-shaped leg and pumice drawer unit, white Kanvas chair.



Labyrinth #2

Pannelli Labyrinth S, M e L in tessuto Frisby A08, giroletti H.29 cm ottanio, tavolino Tac struttura brunito e piano cashmere, scrittoio con cassettera cashmere.

Labyrinth S, M and L panels in Frisby A08 fabric, H.29cm octane bed frame, Tac coffee table with burnished frame and cashmere top, cashmere desk with drawer unit.



Labyrinth #3

Pannelli Labyrinth S e M in tessuto Funny S64 e pannelli S, M e L in tessuto Smack S14, giroletti H.19 cm rovere natural con gambe Ruler brunito, tavolini Tac struttura bianco e piano rovere natural, scrittoio con gamba a elle e cassettera rovere natural, sedia Kanvas bianco.

Labyrinth S and M panels in Funny S64 fabric and S, M and L panels in Smack S14 fabric, H.19cm natural oak bed frame, burnished Ruler legs, Tac coffee table with white frame and natural oak top, desk with L-shaped leg and natural oak drawer unit, white Kanvas chair.



Marker

mensola
shelf



Mensola in metallo con attaccaglia a scomparsa per aggancio a muro, disponibile in due misure e nei colori bianco talco e brunito. Possibilità di attrezzare la mensola con accessori d'aggancio e luce a strip led.
Metal shelf with concealed hardware for wall attachment, available in two sizes, talc white or burnished. Can be equipped with hanging accessories and LED lighting strip.



TECH

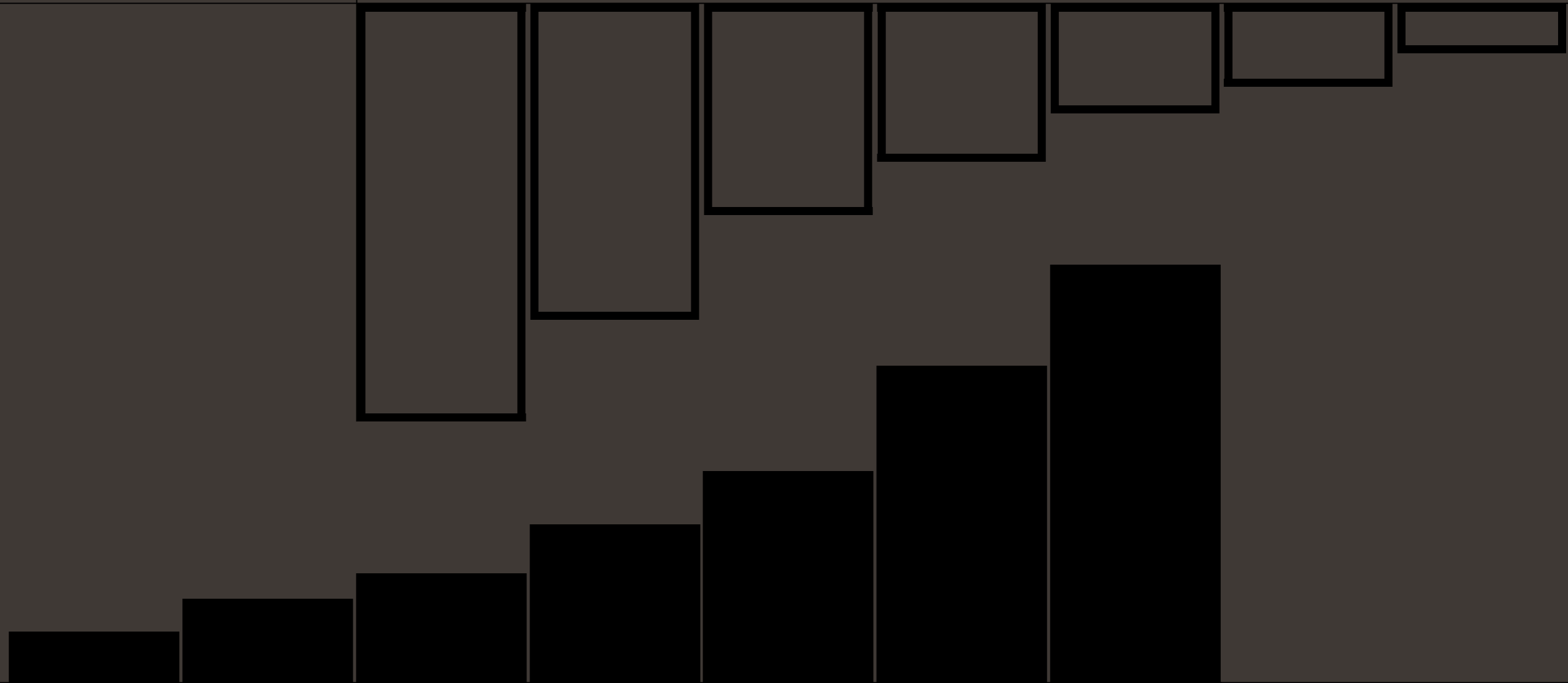

Basi Base units

Basi contenitori Base storage units

A TERRA E IN APPOGGIO
FLOOR-LEVEL AND ELEVATED

P.32,4 - 45,2 - 61,2

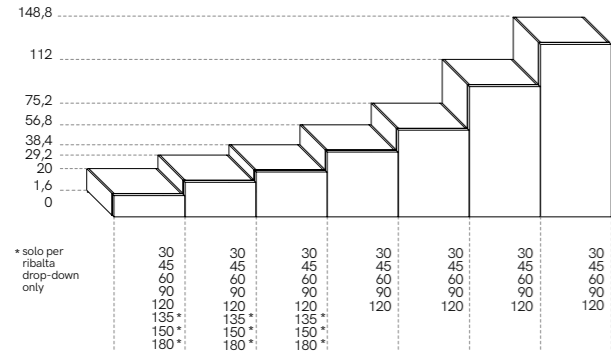

* solo per
ribalta
drop-down
only

SOSPESE
WALL-HUNG

P.32,4 - 45,2

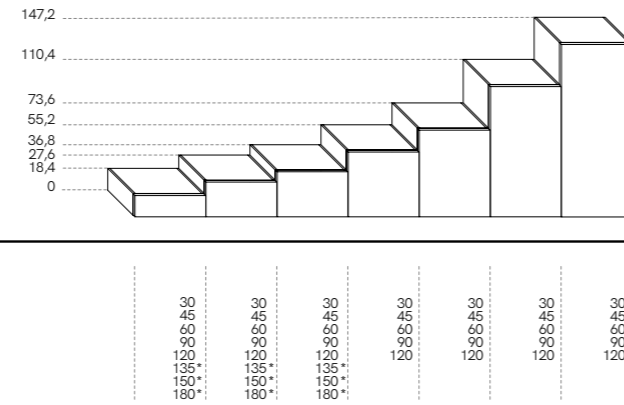

UNOEDUE

Basi sospese e in appoggio
Wall-hung and elevated base units

P.45,2

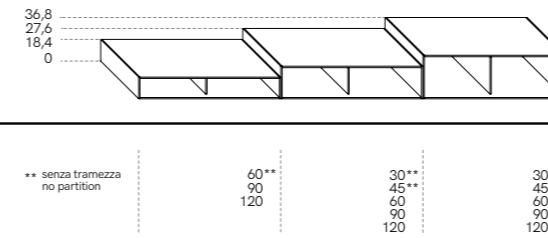

** senza tramezza
no partition

Z45

Basi sospese
Wall-hung base units

P.45,2

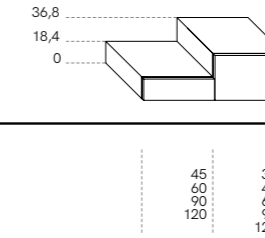

Pensili Wall units

Pensili Wall units

P.32,4 - 45,2

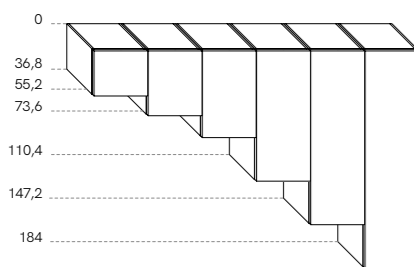

VUOTOPIENO

Pensili
Wall units

P.32,4 - 45,2

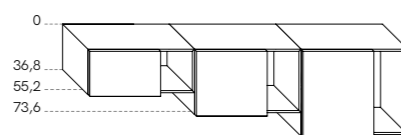

Z45

Pensili
Wall units

P.32,4 - 45,2

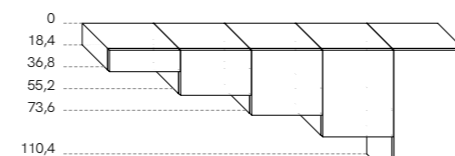

UNOEDUE

Pensili
Wall units

P.32,4

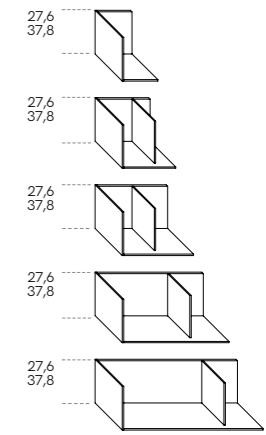
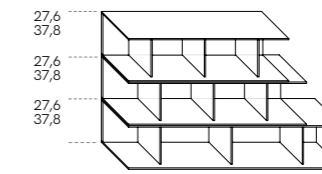
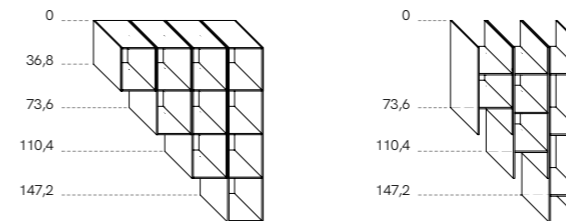

| | | | | | |
|-----|-----|-----|----|----|----|
| 30 | 30 | 30 | 30 | 30 | 30 |
| 45 | 45 | 45 | 45 | 45 | 45 |
| 60 | 60 | 60 | 60 | 60 | 60 |
| 90 | 90 | 90 | 90 | 90 | 90 |
| 120 | 120 | 120 | | | |

| | | |
|-----|-----|-----|
| 45 | 45 | 45 |
| 60 | 60 | 60 |
| 90 | 90 | 90 |
| 120 | 120 | 120 |

| | | | | |
|-----|-----|-----|----|----|
| 45 | 45 | 45 | 30 | 30 |
| 60 | 60 | 60 | 45 | 45 |
| 90 | 90 | 90 | 60 | 60 |
| 120 | 120 | 120 | 90 | 90 |

| | | | |
|-----|----|----|----|
| 30 | 30 | 30 | 30 |
| 45 | | | |
| 60 | | | |
| 90 | | | |
| 120 | | | |
| 135 | | | |
| 150 | | | |
| 180 | | | |

| | | |
|----|----|----|
| 30 | 30 | 30 |
|----|----|----|

| | | |
|-----|-----|-----|
| 135 | 150 | 180 |
|-----|-----|-----|

| | | | | |
|----|----|----|----|-----|
| 30 | 45 | 60 | 90 | 120 |
|----|----|----|----|-----|

Libreria a spalla
Shelving system bookcase

FREESPACE

A TERRA
FLOOR-LEVEL

P.30 - 42,8

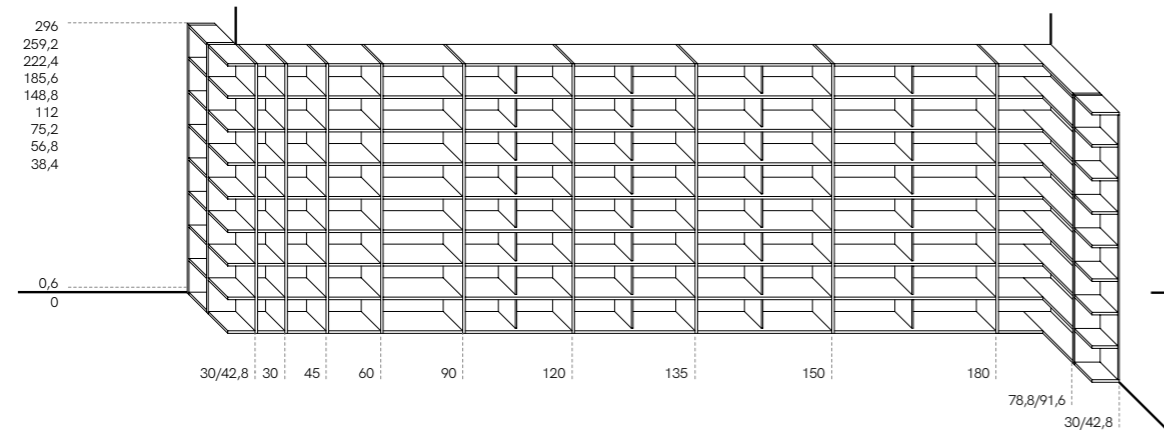

SOSPESA
WALL-HUNG

P.30 - 42,8

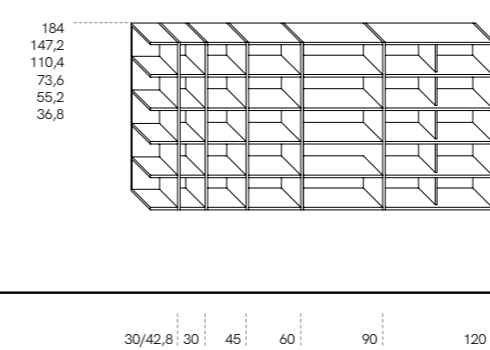

SOSPESA CON RIPIANO USO TOP
WALL-HUNG WITH SHELF USED AS A TOP

P.30 - 42,8

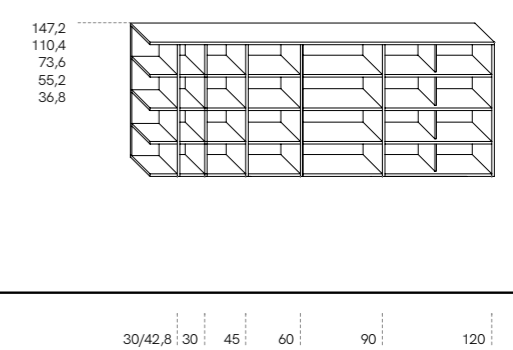

Libreria
Bookcase

WINDY

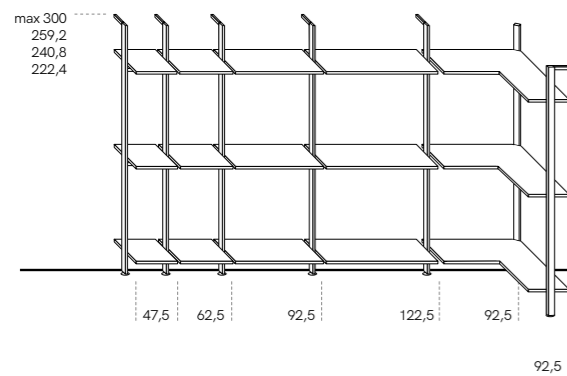

FLEXY EASY

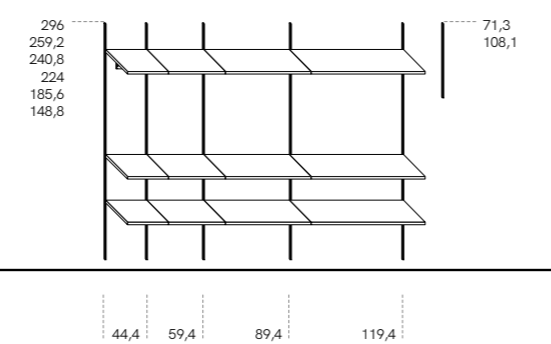

Pannellatura boiserie
Wall panelling

MODULOR

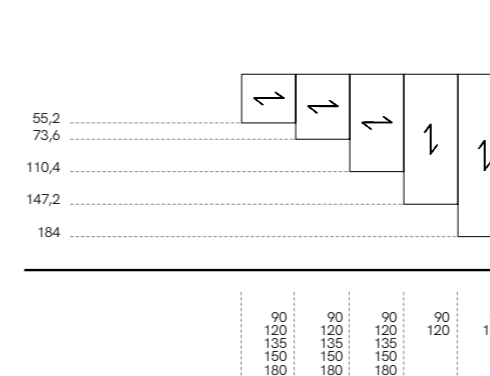

Pannelli tessili
Fabric panels

LABYRINTH

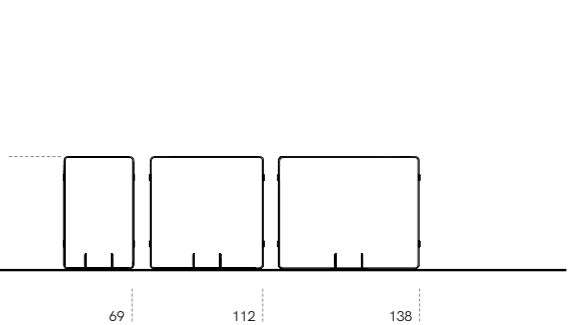

Sistemi cabine armadio
Walk-in closet systems

WINDY

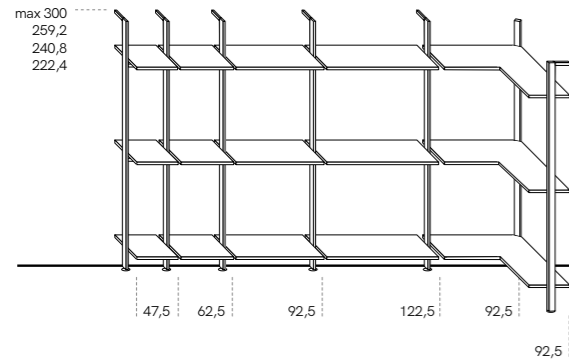

FLEXY

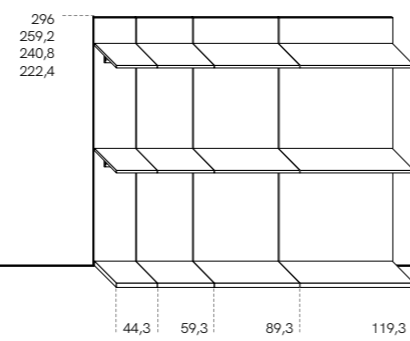

FLEXY EASY

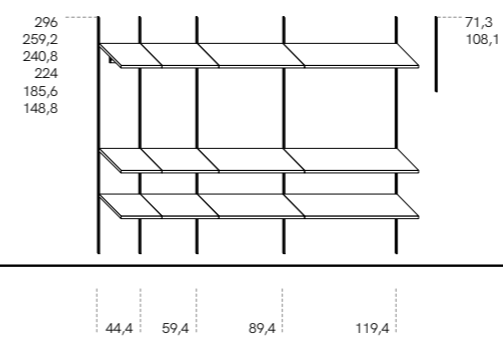

FREE

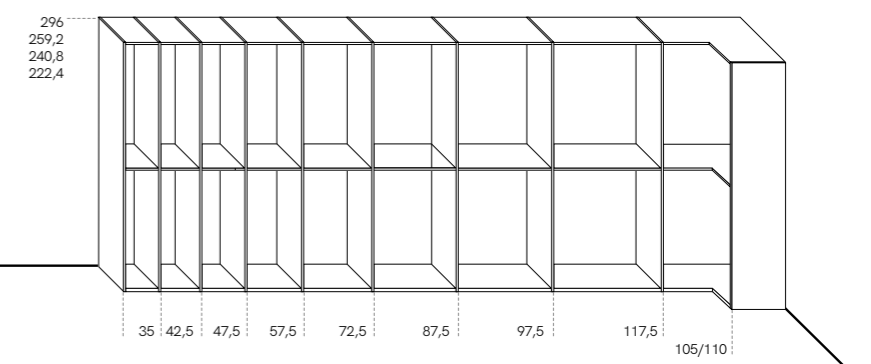

Sistemi armadio
Wardrobe systems

ALTERNA

Battente
Hinged

P.42,8 - 58,8

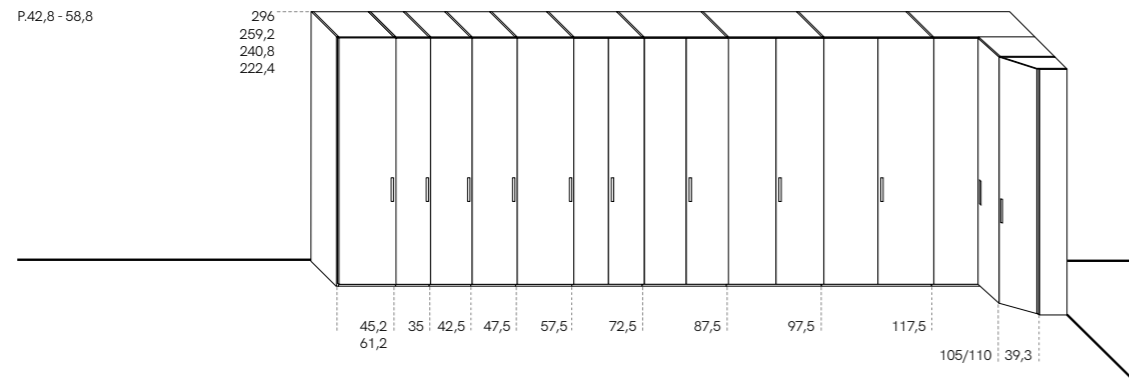

ALTERNA

Scorrevole
Sliding

P.42,8 - 58,8

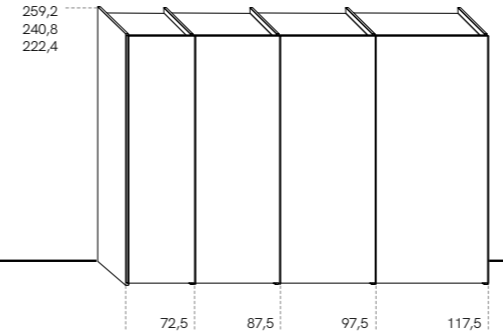

ALTERNA

Complanare
Coplanar

P.42,8 - 58,8



Moduli sovrapponibili
Overhead modules

P.42,8 - 58,8

H.73,6 H.110,4

369,6 406,4
332,8 369,6
314,4 351,2
296 332,8
296
259,2
240,8
222,4

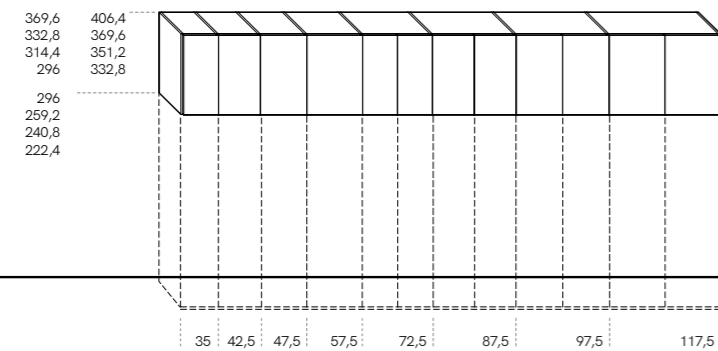

Basi armadio
Wardrobe base units

P.42,8 - 58,8

112
75,2
56,8

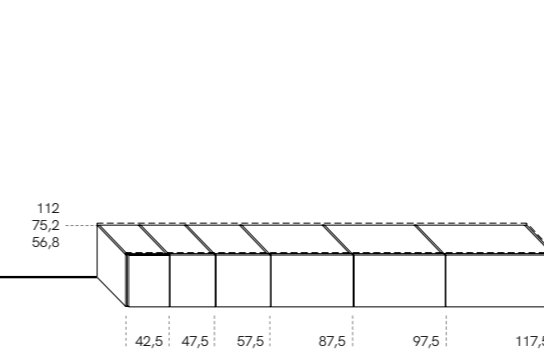

Frontali lisci
Plain fronts

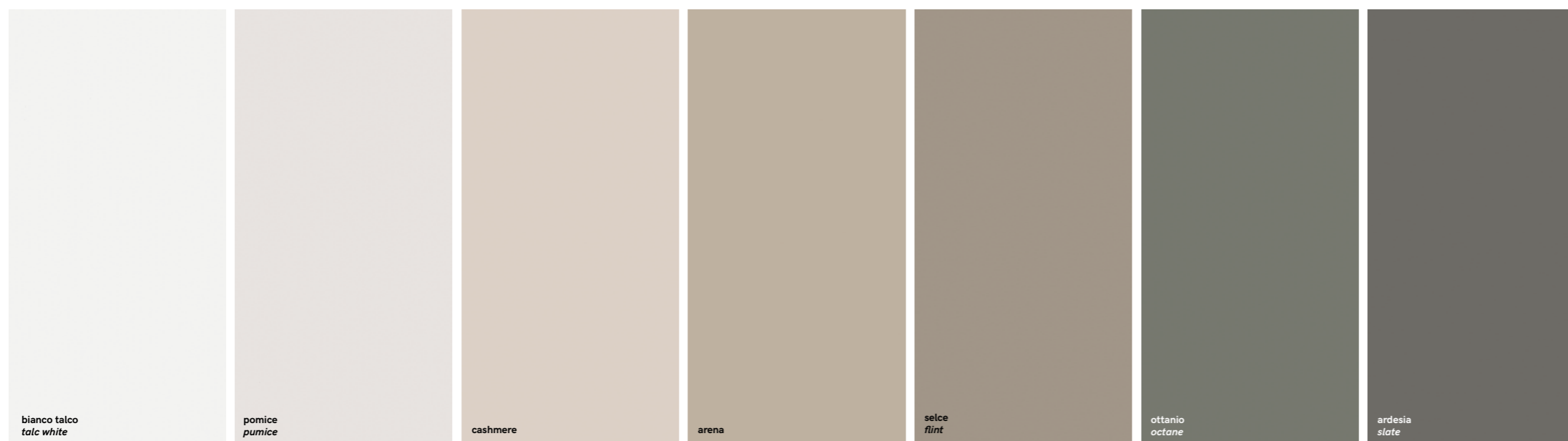

Frontali materici
Textured fronts



* cretto cashmere e cocò disponibili solo per frontali (esclusi cassetti esterni) e pannelli schienale cabina Flexy
cretto cashmere and cocò are only available for fronts (exterior drawers excluded) and Flexy walk-in-closet back panels

Frontali vetro Glass fronts

Vetro
ante
City Glass
Glass for
City Glass
doors



Specchio
ante
Glass
Mirror
for Glass
doors



Vetri lucidi
e opachi
ante Glass
Glossy and
matt glass
for Glass
doors



Frontali vetro per chiusure scorrevoli Glass fronts for sliding doors

Vetri
Glass

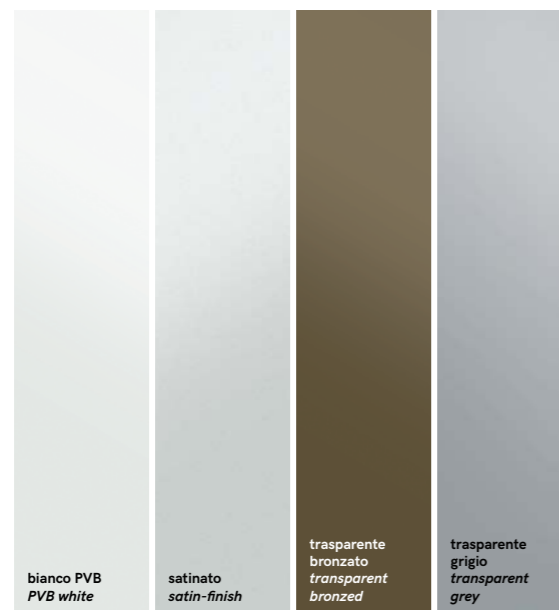

Telai e binari
in alluminio
Frames and
rails in 0
aluminium



Interno armadi Alterna, scocca e attrezzatura interna Alterna wardrobe interiors, carcasses and interior fittings

Noce *
Walnut *



Sesamo
Sesame



* disponibile solo con esterni noce, bianco talco, pomice, cashmere
available with walnut, talc white, pumice and cashmere exteriors only

Tessuti
Fabrics

Frisby

tessuti
idrorepellenti
waterproof
fabrics

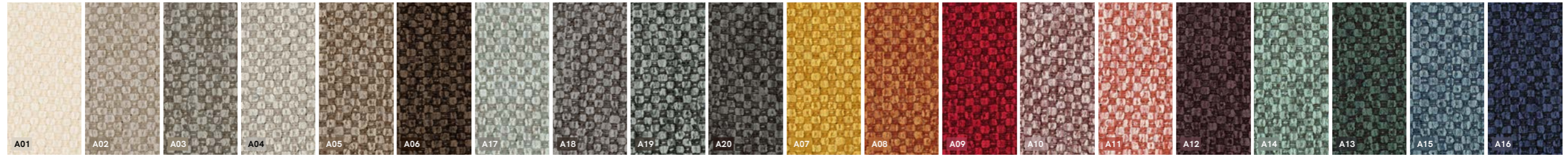

Bloom

ecopelle
eco-leather



Funny

tessuti
cotone riciclato
recycled cotton
fabrics



Smack

tessuti
antimacchia
anti-stain
fabrics

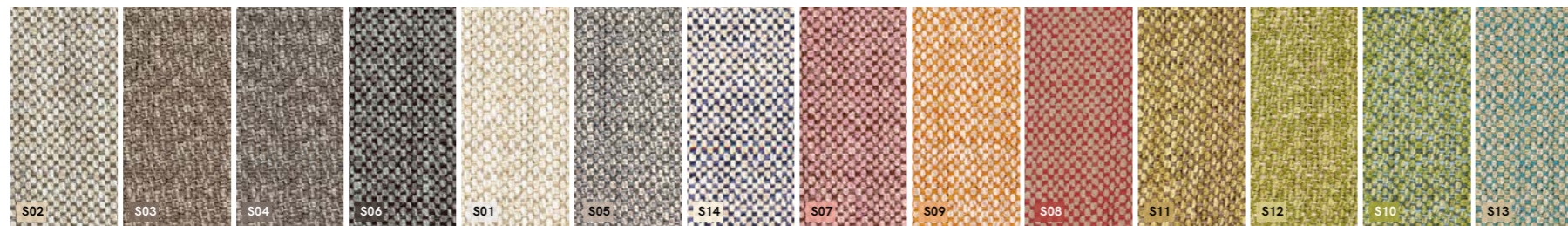

Creta

tessuti
misto lino
linen blend
fabrics

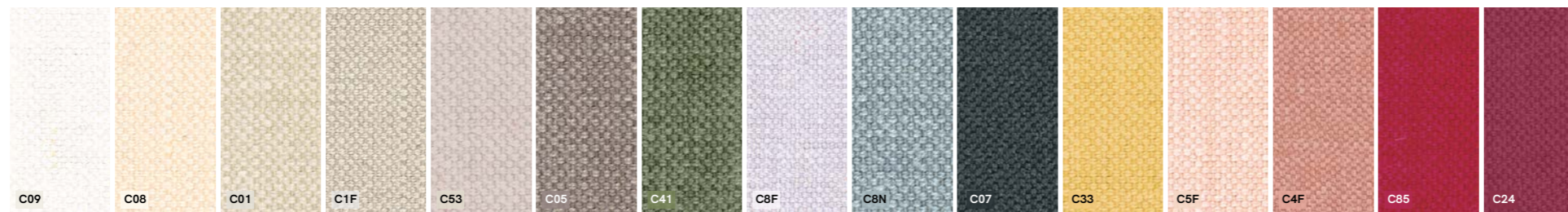

Per i colori, i materiali e gli aspetti tecnici,
fare riferimento ai listini prezzi e relativi aggiornamenti.
For colours, materials and technical specifications
please refer to our price lists and to their updates.

ART DIRECTION
WE ARE DESIGN

PHOTO
Beppe Brancato
Fausto Trevisan

IMAGES
Nudesign

STYLING
Luigina Pilloni
Laura Pasqualato

COLOUR SEPARATION
Nudesign

PRINT
Grafiche Antiga

EDITION
DIV 0925



100% MADE IN ITALY



Via Marosticana, 9
31010 Maser - TV - Italy
Tel. +39 04239255
info@zalf.com



Via Circonvallazione, 21
31020 Falzè di Piave - TV - Italy
Tel. +39 04389861
info@euromobil.com



Via Piave, 25
31028 Tezze di Piave - TV - Italy
Tel. +39 0438 2817
info@desiree.com

gruppoeuromobil.com



ZALF.COM